



## Landslide Fusion Detection Based on Features on Spatial Shape and Spectrum in Massive Data of Aerospace Remote Sensing

---

Chen Shanjing, Xiang Chaocan, Kang Qing, Wang Zhenggang,  
Shen Zhiqiang and Zhou Ruochong

EasyChair preprints are intended for rapid  
dissemination of research results and are  
integrated with the rest of EasyChair.

April 10, 2019

# Landslide Detection Leveraging Spectral-Spatial Correlation Fusion in Aerospace Remote Sensing

Shanjing Chen<sup>1\*</sup>, Zongsheng Zhang<sup>2\*</sup>, Qing Kang<sup>1</sup>, ZhiQiang Shen<sup>1</sup>, Ruochong Zhou<sup>1</sup>

(1. Army Logistics University, Chongqing, China

2. College of Information and Communication, National University of Defense Technology, Wuhan, China.)

**Abstract:** The rapid and accurate detection has been one of the major issues in detecting landslide from massive aerospace remote sensing data. In this paper, we propose a fusion detection model based on back-propagation neural networks to achieve accurate and efficient feature detection on landslide. In specific, we construct a fundamental shape model and apply a scale-invariant feature transform (SIFT) algorithm for feature matching and transformation. By fusing spatial shape features and spectral features, the landslide targets can be further identified and located with high accuracy. We conduct several experimental studies based on aerospace remote sensing data from two real-world scenarios. The experimental results show that the proposed method outperforms the baseline algorithms and achieves up to 95.52% accuracy in landslide detection.

**Index Terms:** Landslide Detection; BP Neural Networks; Features Modeling; Aerospace Remote Sensing

## 1. INTRODUCTION

Landslide is one of the most common and pernicious geological disasters. With the characteristics of wide distribution, great influence and strong destructiveness, landslide poses a great threat to the lives and property of the people [1-2]. The southwest of China is a mountainous region with high susceptibility of landslide. In case of earthquakes or heavy rains, many landslide disasters would occur in above region. Therefore, it is of great importance to achieve quick detection and accurate recognition on landslide when it occurs. Moreover, precise location and coverage information of landslide has significant value for emergency rescue, disaster prevention and mitigation.

With the rapid development of aerospace technology and imaging technology, high-resolution, multi-band, multi-platform and multi-temporal remote sensing provides new opportunities for landslide detection. For

example, Zhang *et al.* [3] proposed a method for landslide detection by combining the Independent Component Analysis (ICA) and the Minimum Noise Fraction (MNF) Transformation. It extracts the change information from two-phase images by GF-1 satellite and conducts segmentation with adaptive thresholds based on histogram. With above process, they achieved accurate detection and recognition on landslide areas. Ling *et al.* [4] took Wenchuan earthquake area as an experimental object for landslide recognition. Based on the remote sensing images from GF-1 satellite and ZY-3 satellite, they developed detection rules and models with fusions of landslide's spectrum, texture and geometric features. Zheng *et al.* [5] proposed a landslide hazard detection method based on word-bag for UAV images. The word-bag features and support vector machine (SVM) are applied into landslide interpretation model to achieve rapid localization and detection of mountain landslide on large-scale and high-resolution images. Ding *et al.* [6] proposed a landslide hazard detection method based on convolution neural networks (CNN) and texture change. Their method extracts suspected landslide areas by convolution neural network. Then, the suspected regions are accurately identified according to the texture change features extracted from remote sensing images that taken before and after disasters. The experiments showed that, this method can accurately detect landslide and extract the disaster information from remote sensing images for landslide occurred in Shenzhen in 2015. Ma *et al.* [7] proposed an automatic detection and recognition method for shallow landslides based on WorldView-2 multi-band optical remote sensing images. They combined features of soil brightness, vegetation index and landslide shadows for target detection. The principal components analysis (PCA) algorithm is used to extract key information from images and automatic threshold segmentation is further applied to detect landslide points.

Lin *et al.* [8] proposed an object-oriented automatic landslide recognition method, which integrates spectral, spatial, topographic and morphological features. Their

---

\*chengshanjing\_11@163.com

\*zhangzongsheng1984@163.com

method can quickly and effectively detect large-scale landslides, using 2.5m high resolution multi-spectrum images by SPOT-5 satellite after Wenchuan earthquake. Li et al. [9] proposed a semi-active landslide hazard area mapping method based on aerial remote sensing images. This method can obtain difference image by analysis of change vector, and then extract the candidate landslide hazard region by threshold segmentation. With eliminated errors by a morphological method, the landslide region is accurately detected by edge grading evolution and regional grading evolution. Chen et al. [10] proposed an automatic landslide detection by data fusion technique using wavelet transform and Taguchi methods. The digital elevation data (DEM) data extracted by airborne LiDAR and images acquired by QuickBird satellite are fused by wavelet transform. The accurate detection of landslides in tropical urban areas is achieved through object-oriented classification and parameter optimization by Taguchi method.

Massive amount of remote sensing data has provided numerous opportunities for landslide detection and recognition. Traditional methods in image interpretation and information extraction are not compatible with the development remote sensing infrastructure. This has become a bottleneck for utilizing massive amount of s remote sensing data in geological hazard detection and identification. Therefore, in this paper, we propose a fusion detection model based on back-propagation neural networks for detecting landslide. We construct a fundamental shape model and apply a scale-invariant feature transform (SIFT) algorithm for feature matching and transformation. By fusing spatial shape features and spectral features, the landslide targets can be accurately identified and located.

## 2. Landslide Detection Model Based on Neural Network by Spectral Features

The error back propagation network (BP neural network) is one of the most widely used and mature neural network models. BP neural network can approximate arbitrary non-linear mapping relations, and it has good generalization ability [11-12]. This paper proposes a landslide detection method based on BP neural networks based on spectral features.

### 2.1 Neuron Model of BP Network

BP neuron basic model structure is constructed based on spectral features of remote sensing data. The nerve has R-dimensional input, and R is the same as spectral dimension of a remote sensing image. Each input is given

a corresponding weight  $w$ . The output of the neuron's transfer function is composed of weighted sum of R-dimensional inputs and deviation. The basic structure of BP network neurons is shown in Figure 1.

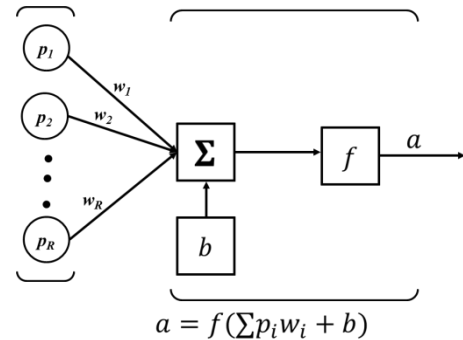

Fig. 1 Basic structure of a BP network neuron model

### 2.2 Transfer function model

In BP networks, transfer function is very important. Typical transmission functions such as logsig, tansig and purelin can be chosen for BP neural networks.

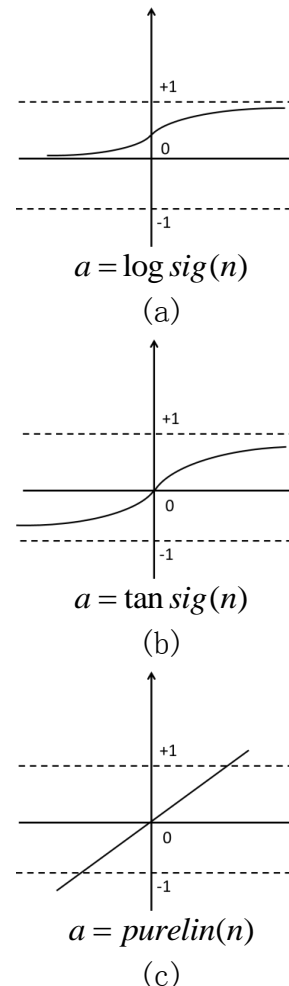

Fig. 2 Typical transfer functions of BP neurons

### 2.3 Structure of BP Neural Network

A detection model based on BP neural network is constructed according to the requirements of landslide identification and summary of experimental results. The model consists of an input layer, an output layer and two hidden layers, as shown in Figure 3. The dimension of

input layer is the same as the spectral dimension of remote sensing image. The number of neurons in the first layer is 10, and the transfer function is logsig. The number of neurons in the second layer is 5, and the transfer function is tansig. The number of neurons in the output layer is 1, and the transfer function is purelin.

and the transfer function is purelin. The number of neurons in the second layer is 5, and the transfer function is tansig. The number of neurons in the output layer is 1, and the transfer function is purelin.

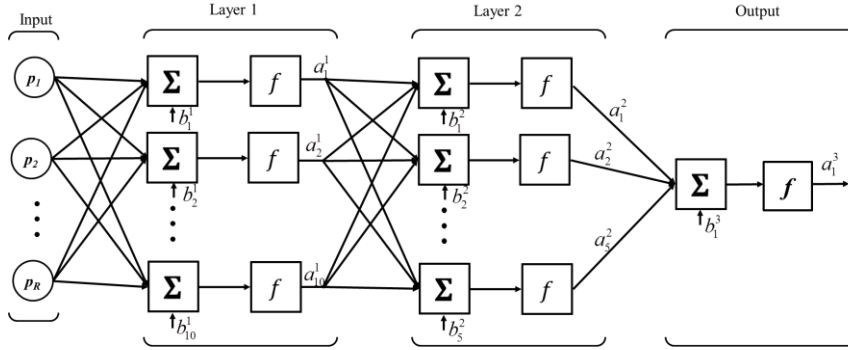

Fig. 3 Landslide detection model based on BP Neural Network

### 3. Landslide detection by Fusing Spatial Shape Features

In order to utilize of landslide spatial shape features in target detection, a SIFT algorithm is applied for feature matching and similarity detection based on landslide detection results by BP neural network. Such that, accurate landslide classification and recognition can be achieved by fusing spatial shape features.

#### 3.1 Construction of Landslide Typical Spatial Shape Model

The surface vegetation of landslide area will be subject to severely damage, and the newly exposed soil and rock are significantly different from the surrounding vegetation coverage in terms of brightness, hue and spatial shape. In this paper, we select two common basic shapes (dustpan shape and triangle shape) of landslide to construct fundamental shape model, which are shown in Figure 4..

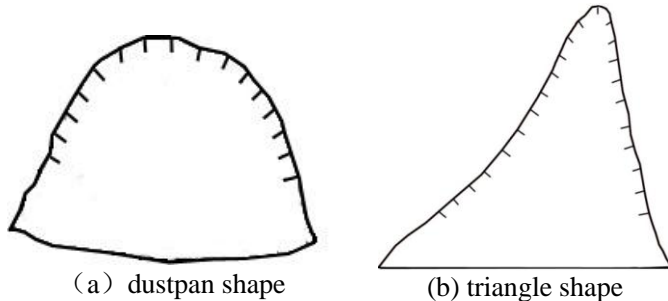

(a) dustpan shape

(b) triangle shape

Fig. 4 Fundamental shape models of landslides

#### 3.2 Feature Detection and Matching Based on SIFT Algorithm

The detection results of BP neural networks are matched with the landslide fundamental feature model by SIFT algorithm. The feature points extracted by SIFT algorithm have scaling invariance, rotation invariance and

affine invariance. These feature points also have certain features in anti-illumination and anti-viewpoint conversion [11-12]. Based on SIFT algorithm, feature point matching can be divided into five steps: scale space extreme value extraction, feature point location, feature direction assignment, feature description extraction and feature matching.

For two-dimensional image  $I(x, y)$ , the Gaussian scale space is defined as  $L(x, y, t)$ , which can be convoluted by Gaussian kernel  $G(x, y, t)$  and  $I(x, y)$ :

$$L(x, y, t) = \begin{cases} G(x, y, t) * I(x, y) & t > 0 \\ I(x, y) & t = 0 \end{cases} \quad (1)$$

where,

$$G(x, y, t) = \frac{1}{2\pi t} e^{-(x^2+y^2)/2t} \quad (2)$$

and  $x, y$ , are the pixel position coordinates of  $L(x, y, t)$ .  $t$  is the scale space factor. It is the variance of the Gaussian normal distribution that represents the smoothing degree of the image.

To efficiently detect stable feature points in scale space, extreme value for Difference of Gaussian (DOG) in the scale space is used as judgment basis. The DOG operator is defined as follows:

$$\begin{aligned} D(x, y, t) &= (G(x, y, kt) - G(x, y, kt)) * I(x, y) \\ &= L(x, y, kt) - L(x, y, t) \end{aligned} \quad (3)$$

The construction of  $D(x, y, t)$  is shown in Figure 5. The DOG local extreme value is detected when the pyramid construction is completed. The extreme value point is funded and saved as the key point, by comparing each pixel with 8 pixels in the surrounding neighborhood of the same scale and 26 pixels in the  $9 \times 2$  pixels corresponding positions

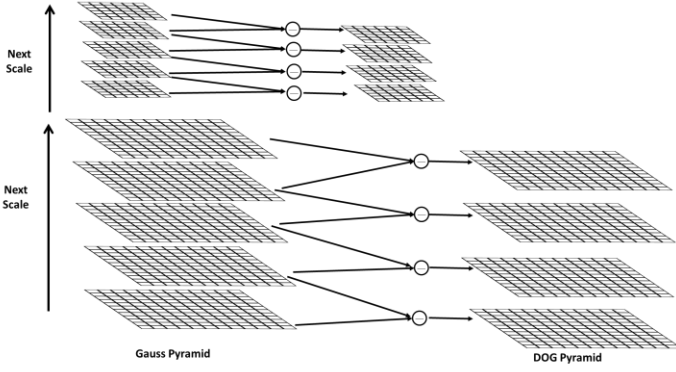

Fig. 5 Construction of Gauss image pyramid and DOG pyramid

The gradient mode and direction of each point in Gauss image are calculated by the gradient distribution of neighborhood pixels, then the direction of key points is determined.

$$m(x, y) = \sqrt{[L(x+1, y) - L(x-1, y)]^2 + [L(x, y+1) - L(x, y-1)]^2} \quad (4)$$

$$\theta(x, y) = \tan^{-1} \frac{L(x, y+1) - L(x, y-1)}{L(x+1, y) - L(x-1, y)} \quad (5)$$

The gradient model and direction of the key points corresponding to the landslide detection results of BP neural network and the landslide typical shape model are extracted by SIFT algorithm, respectively. The key points of optimal matching are found by Two-Dimensional norms, and the minimum Two-Dimensional norm point is selected as the optimal key matching point for feature matching between landslide typical shape model and neural network detection result.

### 3.3 Scale Space Transform and Similarity Detection

The optimal key feature matching points of typical shape model and landslide detection results by BP neural network are used to calculate scale transformation rate and rotation angle. The landslide fundamental shape model is transformed into a target template corresponding to the BP neural network landslide detection result by scale and rotation transformation [15]. The correlation detection method (see Formula 6) is used to detect landslide based on the results of BP neural network detection, which realizes the secondary utilization and further detection landslide by spatial shape features.

$$\rho(x, y) = \frac{\sum_{x=1}^m \sum_{y=1}^n [T(x, y) - \bar{T}] \times [I(x, y) - \bar{I}]}{\sqrt{\sum_{x=1}^m \sum_{y=1}^n [T(x, y) - \bar{T}]^2 \times \sum_{x=1}^m \sum_{y=1}^n [I(x, y) - \bar{I}]^2}} \quad (6)$$

## 4. Basic Flow of Landslide Detection by Spatial and Spectral Features Fusion Based on Neural Network

In order to make full use of spectral and spatial shape feature of remote sensing image, the landslide detection model is established based on BP Neural Network and landslide typical shape feature model. BP Neural Network

is trained by landslide typical spectral samples and background spectral samples. The trained Neural Networks are used to detect the spectral samples of landslide. Then Ostu method is used to segment the results of Neural Networks. Feature detection and matching using fundamental shape models are done. A specific target template corresponding to the landslide detection result is formed through scale and rotation transformation from the fundamental shape model. With this template, landslide targets are further sorted and accurately identified and located. The basic flow of the proposed method is shown in Figure 6.

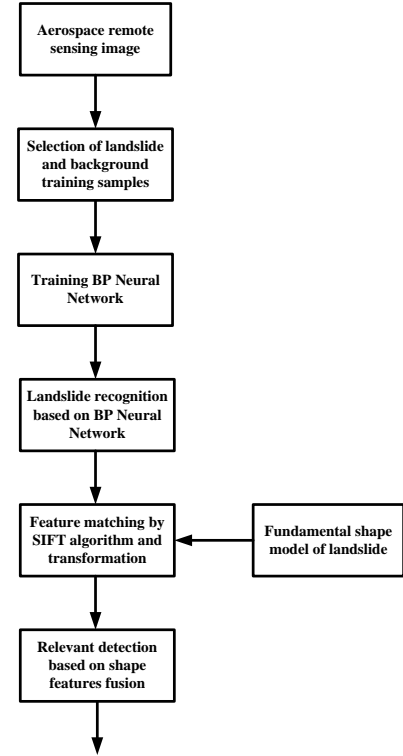

Fig. 6 Basic flow chart of the proposed method in our paper

## 5. Experiments and analysis

### 5.1 Experiment 1

A landslide of about 68m×55m in the west of a college is selected as the research object. The experiment of landslide detection in high resolution satellite remote sensing data of WorldView-4 was carried out. The overall situation of the landslide area is shown in Figure 7. In order to test the proposed method in detecting landslide detection, we proposed algorithms is implemented in MATLAB. The Bayesian classifier and SVM algorithm are compared with the proposed algorithm [16-17]. The selected training sample distribution and the detected sample distribution are shown in Figures 8 and 9. The fundamental shape model (dustpan shaped) of the landslide is shown in Figure 4(a).



Fig. 7 WorldView-4 remote sensing image of landslide area



Fig. 8 Distribution of training samples (Red for landslide samples, green for background vegetation samples and blue for road samples)



Fig. 9 Detecting sample distribution (Red is landslide test sample, blue is background test sample)

The selected BP neural network model is described in Section 2.3, and the maximum number of training is 500, the accuracy of training requirement is 0.01, learning rate is 0.01. Gradient descent method is used for training the neural networks. The training process and results of our BP

neural network are shown in Figure 10 and 11. The kernel function of SVM algorithms is linear. Sequential Minimum Optimization (SMO) is used for searching for classification hyperplanes. The results of Bayes classifier, SVM algorithm and the proposed neural network algorithm for landslide detection are shown in Figure 12. The accuracy and error of landslide detection are shown in Table 1.

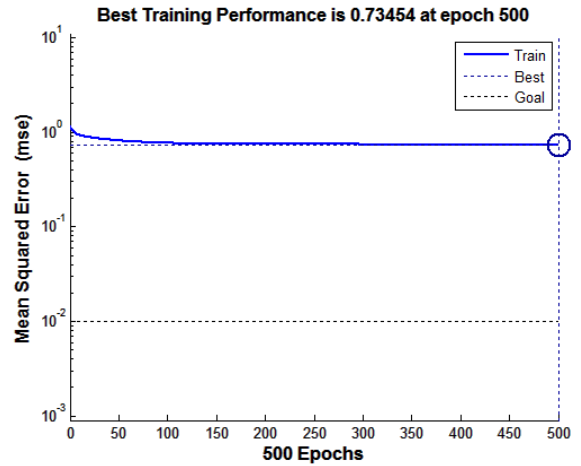

Fig.10 The training performance of our neural network

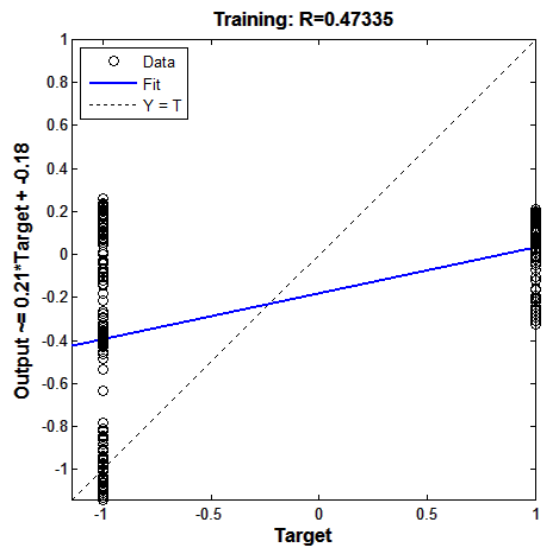
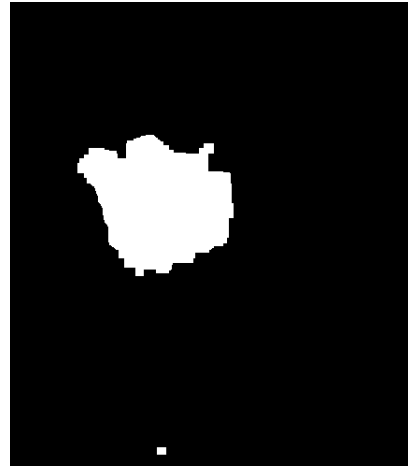

Fig.11 The regression of our neural network



(a) Landslide detection results by Bayes classifier



(b) Landslide detection results by SVM



(c) Neural Network landslide detection method based on spectral features



(d) Landslide detection result based on fusion of spatial shape and spectral features (The Final method proposed in this paper)

Fig. 12 Landslide detection results in WorldView-4 remote sensing images

Table 2 Accuracy and error of four algorithms

	Bayes Classifier	SVM	NN	NN+shape feature (The final method of this paper)
Correct detection rate	93.26%	80.78%	80.91%	85.50%
Missing alarm rate	6.74%	19.22%	19.09%	14.50%
False alarm rate	6.81%	1.05%	2.28%	1.27%

As can be seen from Fig. 12 and Table 1, Bayes classifier has higher accuracy in landslide detection, but it also has higher false alarm rate than other methods, as many non-landslide pixel points are incorrectly identified as landslides. The detection rate of SVM is about 80%. Due to the lack of spatial shape information, the correct detection rate is not high. The results of landslide detection based on

spectral feature and neural network are similar to those of SVM, both of them are unsatisfied. The landslide detection method based on spectral feature and neural network cannot accurately identify the blue rectangular roof in the upper right corner of the image, which is made a mistaken for a landslide. Landslide detection method based on Neural Network and spatial-spectral feature fusion can accurately

distinguish landslides from roofs, and accurate detection of landslide area is realized by spatial feature fusion. The all-over detection accuracy of our proposed method is better than other methods.

### 5.1 Experiment 2

A landslide near a mountain road from Nanchuan District to Wansheng District of Chongqing City is selected as the research object. The experiment of landslide detection in high resolution satellite remote sensing data of WorldView-2 was carried out. The overall situation of the landslide area is shown in Figure 13. The selected training sample distribution and the detected sample distribution are shown in Figures 14 and 15. The basic shape model (Triangle) of the landslide is shown in Figure 4(b).



Fig. 13 WorldView-2 remote sensing image of landslide area

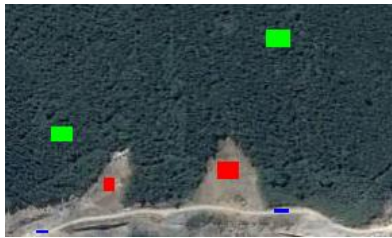

Fig. 14. Distribution of training samples (Red for landslide samples, green for background vegetation samples and blue for road samples)

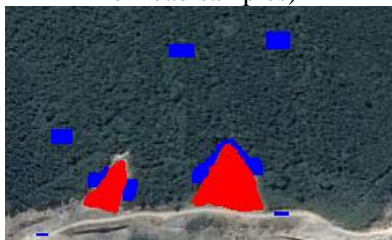

Fig. 15 Detection sample distribution (Red is landslide test sample, blue is background test sample)

The parameters of the selected BP neural network model, Bayes classifier and SVM algorithm are the same as Experiment 1. The training process and results of our BP neural network are shown in Figure 16 and 17. The results of landslide detection by three algorithms are shown in Fig. 18. The accuracy and error of landslide detection are shown in Table 2.

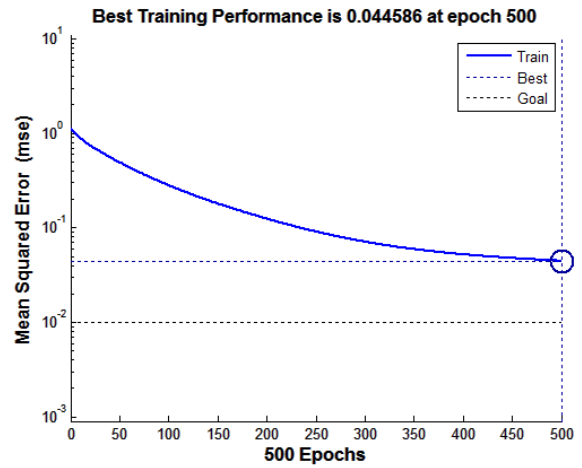

Fig.16 The training performance of our neural network

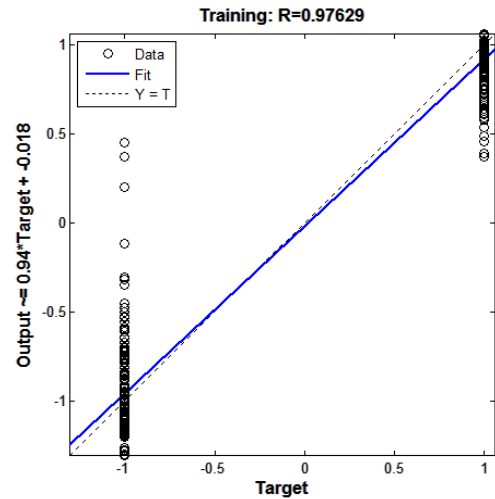

Fig.17 The regression of our neural network



(a) Landslide detection results by Bayes classifier



(b) Landslide detection results by SVM

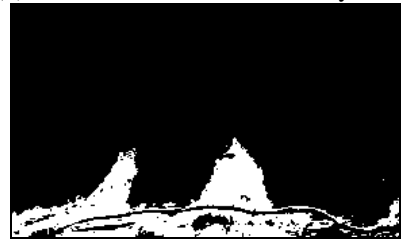

(c) Landslide detection result based on fusion of spatial shape and spectral features (The Final method proposed in this paper)

Fig. 18 Landslide detection results in WorldView-2 remote sensing images



Table 2 Accuracy and error of three algorithms

	Bayes classifier	SVM	NN+shape feature (The final method of this paper)
Correct detection rate	73.71%	100%	95.52%
Missing alarm rate	26.29%	0%	4.48%
False alarm rate	0.36%	8.78%	1.38%

As can be seen from Fig. 11 and Table 2, Bayes classifier has poor accuracy in landslide detection, and 26% of landslide test samples are not detected in landslide remote sensing image of this area. The correct detection rate and missing alarm rate of SVM are very good, but the false alarm rate is high. The proposed algorithm achieves higher overall recognition rate, by making use of spectral and spatial shape features, and it can maintain a low false alarm rate. Overall, the performance of landslide detection of our proposed method is better than the two baseline algorithms.

## 6. CONCLUSION

In this paper, we propose a fusion detection model based on back-propagation neural networks to achieve accurate and efficient feature detection on landslide. The spectral features and shape features are extracted from aerospace remote sensing images. We construct a basic shape model and adopt the SIFT algorithm for feature matching and transformation. By fusing spatial shape features and spectral features, the landslide targets can be further identified and located with high accuracy. The experimental results show that the proposed method outperforms the baseline algorithms and achieves up to 95.52% accuracy in landslide detection.

## REFERENCES

- [1] Chen F., Yu B., Li B. A practical trial of landslide detection from single-temporal Landsat8 images using contour-based proposals and random forest: a case study of national Nepal[J]. *Landslides*, 2018,15 (3): 453–464.
- [2] Nicola C., William F., Stefano M., et al. Spaceborne, UAV and ground-based remote sensing techniques for landslide mapping, monitoring and early warning [J]. *Geoenvironmental Disasters*, 2017, 4 (9): 1–23.
- [3] Zhang H. T., Cheng X. W., Chen X. Y., et al. Landslide disaster detection method of high resolution remote sensing image based on ICA/MNF[J]. *Journal of Catastrophology*, 2015, 30(1): 193-197.
- [4] Peng L., Xu S. N., Mei J. J., et al. Earthquake-induced landslide recognition using high-resolution remote sensing images[J]. *Journal of Remote Sensing*, 2017. 21(4): 509-518.
- [5] Li Z., Li Y. S., Guo J. W., et al. An automatic landslide interpretation model of UAV imagery based on BoW[J]. *Remote Sensing Information*, 2016, 31(5): 24-29.
- [6] Ding A. Z., Zhang Q. Y., Zhou X. M., et al. Automatic recognition of landslide based on CNN and texture change detection[C]. 31st Youth Academic Annual Conference of Chinese of Chinese Association of Automation, 2016, 11: 444-448.
- [7] Ma H. R., Cheng X. W., Chen L. J., et al. Automatic identification of shallow landslides based on Worldview2 remote sensing images[J]. *Journal of Applied Remote Sensing*, 2016, 10 (1): 1600801–1600812.
- [8] Lin Q. G., Zou Z. H., Zhu Y. Q., et al. Object-oriented detection of landslides based on the spectral, spatial and morphometric properties of landslides [J]. *Remote Sensing Technology and Application*, 2017, 32(5): 931-937.
- [9] Li Z. B., Shi W. Z., Myint S. W., et al. Semi-automated landslide inventory mapping from bitemporal aerial photographs using change detection and level set method[J]. *Remote Sensing of Environment*, 2016,175 (1): 215–230.
- [10] Chen W. T., Li X. J., Wang Y. X., et al. Data fusion technique using wavelet transform and taguchi methods for automatic landslide detection from airborne laser scanning data and QuickBird satellite imagery[J]. *IEEE Transactions on Geoscience and*

- Remote Sensing, 2016 , 54 (3): 1610-1622.
- [11] Kumar R., Anbalagan R. Remote sensing and GIS based artificial neural network system for landslide susceptibility mapping[C]. IEEE International Geoscience and Remote Sensing Symposium, 2015, 4696 – 4699.
- [12] Li T., Zhang Y. X., Lv Z. Y., et al.Landslide inventory mapping from bitemporal images using deep convolutional Neural Networks[J]. IEEE Geoscience and Remote Sensing Letters, 2019, (2): 1 – 5.
- [13] Ma W. P., Wen Z. L., Wu Y., et al. Remote sensing image registration with modified SIFT and enhanced feature matching[J]. IEEE Geoscience and Remote Sensing Letters, 2017, 14(1): 3-7.
- [14] Amin S., Hamid E. Remote sensing image matching based on adaptive binning SIFT descriptor[J]. IEEE Transactions on Geoscience and Remote Sensing, 2015, 53 (10): 5283 – 5293.
- [15] Huang X., Yuan W. L., Li J. Y., et al. A new building extraction postprocessing framework for high-spatial-resolution remote-sensing imagery[J]. IEEE Journal of Selected Topics in Applied Earth Observations and Remote Sensing, 2017 , 10(2): 654 – 668.
- [16] Majid M., James V. A., Rodrigo A. A., et al.A machine learning framework for detecting landslides on earthen levees using spaceborne SAR imagery[J], IEEE Journal of Selected Topics in Applied Earth Observations and Remote Sensing, 2015,8(8): 3791 – 3801.
- [17] Xu H., Li X., Gong W. Y., et al. Research on recognition of landslides with remote sensing images based on extreme learning machine[C]. IEEE CSE and EUC, 2017, 1:740 – 747.