



LiDAR Assessments and Mapping for Klang Valley: a Case Study at Jinjang District, Selangor

Roslina Idris, Rabieahtul Abu Bakar and
Abdul Rauf Abdul Rasam

EasyChair preprints are intended for rapid dissemination of research results and are integrated with the rest of EasyChair.

November 8, 2022

LiDAR ASSESSMENTS AND MAPPING FOR KLANG VALLEY: A CASE STUDY AT JINJANG DISTRICT, SELANGOR

KEY WORDS: LiDAR, DSM, DTM, RMSE, Accuracy, Digital Models.

ABSTRACT:

Light Detection and Ranging (LiDAR) technology has become a significant factor in producing up-to-date and accurate topographic data in the current world. LiDAR technology has been used for years for many applications, including the efficient creation of digital model for large scale, high accuracy mapping. This technology offers fast, accurate, expedient and cost-effective ways of capturing wide area elevation information to produce highly detailed digital model of the earth. LiDAR is based on airborne laser scanners enables to acquire dense and accurate 3D data of the surveyed area, i.e., the Digital Surface Model (DSM). This paper presents an exploratory study to assess the accuracy of constructed DTM (Digital Terrain Model) and evaluating ground height without surface features using LiDAR Digital Surface Model (DSM). The study area comprised of an undulated area situated at Jinjang in the Klang Valley region, Malaysia covering an area of one kilometre square. LiDAR DSM and DTM constructed and derived from LiDAR were critically assessed with reference to the USGS Map Accuracy Standards. The accuracy of derived DSM and DTM were evaluated using ground control points derived from conventional surveying technique. The constructed models were assessed quantitatively and qualitatively.

1. INTRODUCTION

1.1 Study Background

Airborne laser scanning technology allows the capture of very dense 3D point clouds from the terrain and surface features. LiDAR lasers send a signal to the ground from an aircraft which bounced after hitting the ground surface back to the aircraft. The time for the light to travel out to the ground and back to the aircraft is used to determine the vertical distance of the features on the ground that it bounced from, thus, the “lay of the land” is recorded to a great accuracy (Ruijin, 2004) and (Wasser, 2020). This technology has become one of the outmost accurate, cost-effective topographic elevation data collecting techniques for large areas (Zolanvari, S. M., et al, 2019). It provides three dimensions (3D) or (x, y, z) information for the construction and the creation of digital model such as DSM with high accuracy in a short delivery time (Mesa-Mingorance et al, 2020) with vertical accuracies of 15 to 100 centimetres (Cheng, L et al., 2018).

LiDAR techniques integrates three matured technologies: a rugged compact laser range finder, a highly accurate Inertial Navigation System (INS) and the Global Positioning System (GPS) (Idris et al., 2014) as depicted in Figure 1. Integrating these subsystems into a single instrument, it is possible to rapidly produce an accurate DSM of the terrain beneath the flight path of the aircraft (Idris, 2008).

However, several factors affecting the accuracy of an elevation model have been identified such as accuracy of LiDAR data inputs, models used to generate elevation models, filtering techniques and terrain characteristics need special attention in generating desired elevation model (Huang, J et al., 2019).

A digital model is a way of representing the surface terrain or a derived surface by means of mathematical expression. There are a couple of ways to define the digital models, which represent the Earth’s surface, but following definitions are used in this

research. A digital terrain model (DTM) is a digital representation of terrain relief of Earth surface (georelief) in computer memory, composed of (sample) data and algorithm which can interpolate heights of intermediary points (Mesa-Mingorance, J. L., 2020).

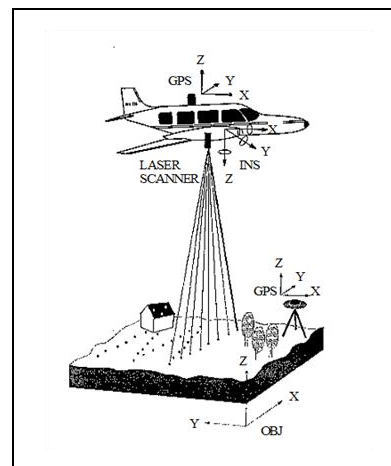

Figure 1. Airborne LiDAR (Ackermann, 1997)

Consequently, upon the mentioned definitions, this bare-earth DEM is generally synonymous to Digital Terrain Model (DTM) (Figure 2). A digital surface model (DSM) is usually constructed using automatic extraction. DSM represents top faces of all objects on the terrain (both vegetation and manmade features) or terrain itself in open areas (Croneborg, L et al., 2020).

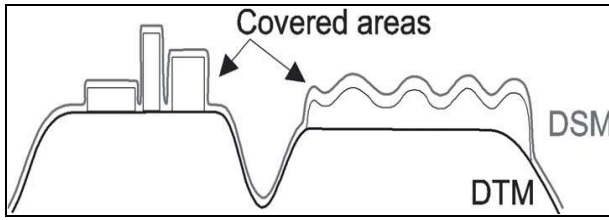

Figure 2. Difference between DTM (or DEM) and DSM

In this study, Digital Terrain Model derived from LiDAR dataset will be constructed. The accuracy of the derived (DSM and DTM) will be critically assessed qualitatively and quantitatively. In Malaysia, the Malaysian standard for topographic map production is not published. However, it is generally understood that, Malaysian topographic map do comply with a certain set of standards (Ramli, 2018). Since there is no published information on Malaysian Standards to produce topographic map, the ASPRS Positional Accuracy Standards Digital Geospatial Data (2014) and USGS Map Accuracy Standards (1947) are adopted for this study. With the popularity of this technology, the datasets supplied seems appealing for the purpose of topographic map production and revision (Lakshmi, S. E et al., 2018).

2. STUDY AREA

2.1 Data Acquisition

The study area is located within the Klang Valley. Klang Valley consists of 13 main regions, namely are Shah Alam, Petaling Jaya, Subang Jaya, Puchong, Klang, Rawang, Serdang, Ampang, Gombak, Selayang, Sepang, Hulu Langat and Kajang. The chosen study area represents a developed area with varying topography (Figure 3) situated at Jinjang in the Klang Valley region, which the tile (1km x 1km) was extracted from the LiDAR coverage of 10km x 10km.

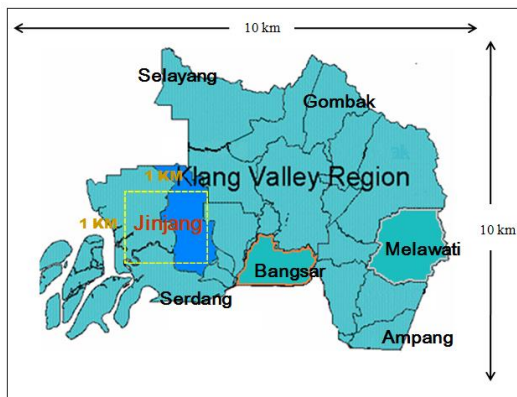

Figure 3. Location of study area at Klang Valley Region

LiDAR DSM for the study area (Figure 3) was supplied by the Malaysian Remote Sensing Agency (MYSA) with grid spacing of 2m interval in American Standards Code for Information Interchange (ASCII) format with x, y, z coordinate. The datasets were acquired from 25th to 27th October 2017 using the Optech System with the following specification and proclaimed accuracy. Specifications of the acquired LiDAR datasets are as shows in Table 1.

Aircraft for data acquisition	British Normad 2
Sensor	First Class Infrared Laser
Laser System	Optech System
Flying Height	550m
Datum	Kertau
Data Format	ASCII
Resolution (Spacing)	Less than 2m
Accuracy	± 30 cm (Horizontal) & ± 15 cm (Vertical)
Projection	Rectified Skew Orthomorphic (RSO)

Table 1. Specifications of the acquired LiDAR datasets

2.2 Control Points and Field Vector Lines

Control points and vector lines were established within the study area to act as reference points for the quantitative assessment. Eight (8) well-defined points (control points) were observed using Global Positioning System (GPS) and tachymetry surveying method to utilize in the determination of the control points within the survey area. Figure 4 shows the location of control points (ground data) for the study area observed using GPS. The control points were used to validate the accuracy of DSM and DTM derived from LiDAR dataset. For the vector line, RMSExy or horizontal accuracy evaluation data from ground survey which includes the building and road outlines were used for this analysis (Idris, 2008). From the tachymetry surveying method, the data were used to transfer coordinate from well-defined GPS points (datum) to the checkpoints (building and road outlines) at the study area. The selected building outline, edges and road outline were used as the references points to calculate the discrepancies between the horizontal differences (RMSExy). Buildings outline from LiDAR DSM will be generated and compared with the selected corner of the building and road outline. Sixteen (16) points were used in this study for the building edge and roads outlines and the RMSE results are shown table 1 and the Root Means Square Error (RMSE) results are shown table 2.

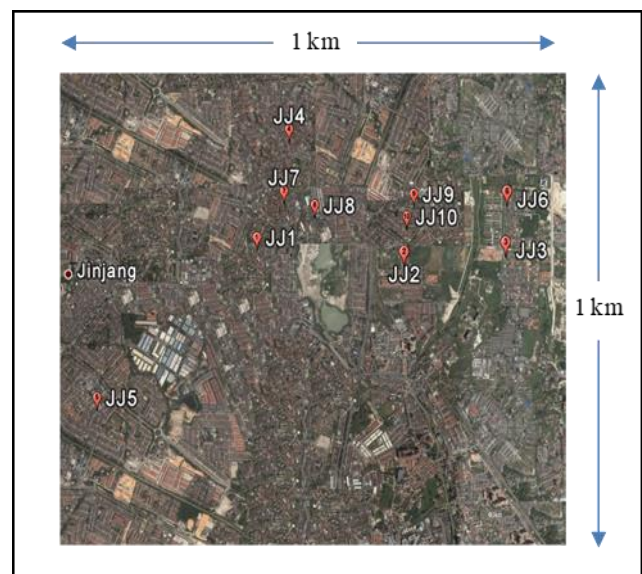

Figure 4. The locations of these GPS control points

3. METHODOLOGY

3.1 DTM creation from LiDAR return

Raw LiDAR data is a collection of mass points with XYZ coordinates. The point data are then post processed and classified into two main classes of point which are: the last return from ground and the first return from tops of vegetation or building or structures. In this study, the acquired LiDAR DSM data were processed to generate DTM (McGaughey, 2018). For the creation of DTM, the LiDAR DSM was imported into TerraScan Software (TerraScan, 1999, Liu *et al* 2018). TerraScan is a dedicated software solution for processing laser scanning points. It can handle millions of points as all routines are tweaked for optimum performance (Bc-Carms, 2006). TerraScan classify the points from non-ground and ground LiDAR datasets. LiDAR datasets were then filtered, cleaned and classified into non-ground (DSM) (figure 5(a)) and ground (DTM) (figure 5(b)) using The TerraScan Software.

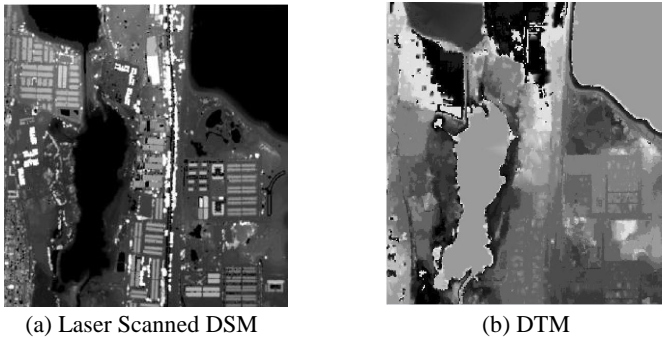

Figure 5. (a) & (b) are construction of DTM from LiDAR DSM dataset

Digital terrain model (DTM) were derived from point cloud by separating last returns and applying specific filtration methods to them, while Digital surface model (DSM) is constructed from first returns (Okolie *et al* 2022). The LiDAR DSM/DTM is shown in grayscale where heights variations are depicted in different tones of the grey level.

4. MEASURE OF ACCURACY

4.1 Root Mean Square Error (RMSE)

Accuracy describes how close a data value is to the true value or relating the value to an established standard of reference. It is a relative rather than an absolute concept: it cannot be endowed with a rigid definition such as ‘in exact conformity to truth’ or ‘free from error or defect’.

Accuracy can be measured in different ways (Idris, 2008), both quantitatively (numerically) and qualitatively (descriptively). However, the quantitative expression is much more acceptable to the scientific community (Cardenas-Martinez, 2022) and (The University of Kansas, 2022).

In this study, quantitative assessment will be based on the computation of RMSE between control points gathered and derived values from the LiDAR datasets (DSM and DTM). For the qualitative assessment, various plots of mismatch between tested dataset and known vector line will be displayed. Vector line derived from ground survey overlay with LiDAR DSM plotted at scale 1:10,000.

RMSE was calculated at randomly selected control points (Harley, 1975) and (Akturk, E *et al.*, 2019).

$$RMSE_z = \pm \sqrt{\frac{\sum_{i=1}^{i=n} (Z_i - Z_i^*)^2}{n}}$$

(1)

Where, n is the number of check points; Z_i is the heights derived from LiDAR DSM and derived DTM at control point i and Z_i^* is the control point height at the same position on the ground.

For the horizontal components, equation 2 will be utilised for distinct or well-defined points on the LiDAR DSM and the constructed DTM.

$$RMSE_{(x,y)} = \pm \sqrt{\frac{\sum_{i=1}^{i=n} ((X_i - X_i^*)^2 + (Y_i - Y_i^*)^2)}{n}}$$

(2)

Where, n is the number of check points; X_i and Y_i are the coordinates of the control points i derived from LiDAR DSM and DTM, X_i^* and Y_i^* are the coordinates of control points at the same position on the ground.

4.2 Validation LiDAR for Mapping Application and Revision

Based on ASPRS Positional Accuracy Standards for Digital Geospatial Data 2014, the standard accuracy for LiDAR root mean square error (RMSE) in LiDAR elevation is presented in Table 2. The root mean squared error (RMSE) in positioning is calculated based on the aircraft flying at varying heights while collecting LiDAR data. The flying altitude is measured in metres, but the RMSE is going to be in centimetres.

Altitude (m)	Positioning RMSE (cm)
500	13.1
1,000	17.5
1,500	23.0
2,000	29.0
2,500	35.2
3,000	41.6
3,500	48.0
4,000	54.5
4,500	61.6
5,000	67.6

Table 2. LiDAR Standard Accuracy based on ASPRS 2014

The root mean square error (RMSE) for x and y is displayed in Table 4 along with the RMSE for ground data. Pdhstar’s August (2018) research claims that the ASPRS 2014 places limits on RMSE x and y varies depending on the altitude of the airborne LiDAR (Rodarmel *et al* 2006). Since the LiDAR data acquired

was flown 500m above terrain, the result must not exceed 13.1cm to be considered accurate.

Meanwhile, the accuracy standard of topographic map is based on the standard set by the Standards Committee of the American Society of Photogrammetry and Remote Sensing (ASPRS), 1947 (ASPRS, 2005). The standards ensure that the accuracy specifications are appropriate for the published map series in United States. In Malaysia, the USGS (United State Geological Survey) Map Accuracy standards (1947) are adopted. Table 3 shows the USGS Map Accuracy Standards (1947) for various map scale.

Scale	Horizontal Accuracy (x,y,z)	Contour Interval (m)	Vertical Accuracy (z)
1:30 00	± 2.55m		
1:5 000	± 4.25 m		
1:7 500	± 6.41m	5 m	± 2.5 m
1:10 000	± 8.50 m		
1:12 500	± 10.62 m		
1:25 000	± 12.50 m	20 m	± 10 m
1:50 000	± 25.00 m		

Table 3. USGS Map Accuracy Standards (1947)

For topographic map produced by USGS (United State Geological Survey), meeting these accuracy requirements shall have the statement “This map complies with national map accuracy standards” printed on the map sheet. Referring to the USGS standard, the permissible error of the vertical accuracy (Root Mean Square Error) for the tested points (90% of tested point) should be less than one-half of the published contour intervals.

5. RESULT

5.1 Quantitative Analysis

Quantitative assessment will be based on the computation of RMSE between control points gathered from ground survey and derived values from the LiDAR datasets (DSM and DTM). The accuracy obtained will then be referred to the ASPRS Positional Accuracy Standards for Digital Geospatial Data 2014 with flying height and USGS Map Accuracy Standards (1947) (US Bureau, 1947) with scale 10:000.

Distribution of the checkpoints for the quantitative assessment is shown in Table 4.

Area	Category	No. of points	Total of points
Jinjang	Flat Ground	8	24
	Building	7	
	Road	9	

Table 4. Distribution of checkpoint for ground survey

Table 5 shows the RMSEz plot for the study area. The accuracy estimates are computed based on Equation 1. The accuracy

computed for LiDAR DSM and DTM are $\pm 0.040\text{m}$ and $\pm 0.012\text{m}$ respectively for the study area (Jinjang). The derived accuracy of the LiDAR dataset is the stated accuracy (Table 1) of the LiDAR data which is between 0.1m to 0.5m (Cheng, L et al., 2018) tolerable limits claim by the manufacturer (Jaafar, 2004).

Scale	1:10,000		Comment
	LiDAR DSM	LiDAR DTM	
Quantitative	0.040 m (z) 0.262 m (xy)	0.012 m (z) 0.323 m (xy)	Comply with USGS Map Accuracy Standards (1947)
Qualitative			<ul style="list-style-type: none"> Roads difficult to define Buildings in good agreement with surveyed line

Table 5. RMSEz and RMSExy for ground at scale 1:10,000

Planimetric accuracy for both LiDAR DSM and DTM datasets were evaluated using equation 2. The accuracy estimates derived for the horizontal components (RMSExy) of LiDAR DSM and DTM are $\pm 0.262\text{m}$ and $\pm 0.323\text{m}$ respectively (Table 5). With this accuracy, creation or revision of a topographic map seems possible, whereby it is within the tolerable limits of the USGS Map Accuracy Standards (1947) for the 1:10,000 published scales (Fennel, 2021).

5.2 Qualitative Assessment

Another part of the evaluation process is to analyses the result graphically, as it was difficult to be described otherwise. Consequently, the second approach for the assessment involved graphical output. Qualitative assessment is carried out by overlapping these dataset and observed the mismatch of define features (i.e: well-defined building outlined and roads) between LiDAR DSM with ground survey dataset (or reference dataset).The ground survey dataset is obtained using the tachymetry surveying method. The process is executed using the Arc Tool-Arc Map software (ESRI, 2022) and (Arcmap, 2019).

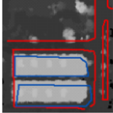
Figure 6 shows the qualitative plot for the Jinjang LiDAR DSM. Referring to Figure 6, the ground survey dataset (vector line) for buildings seems to be in good agreement with the LiDAR DSM because building outline are able to be seen clearly using the 1:10,000 scale. The LiDAR dataset are capable to be used as a source of data for mapping and provides a very reliable source for building outlines. This shows that, integrating LiDAR DSM towards topographic map revision at 1:10,000 scales seems appealing.

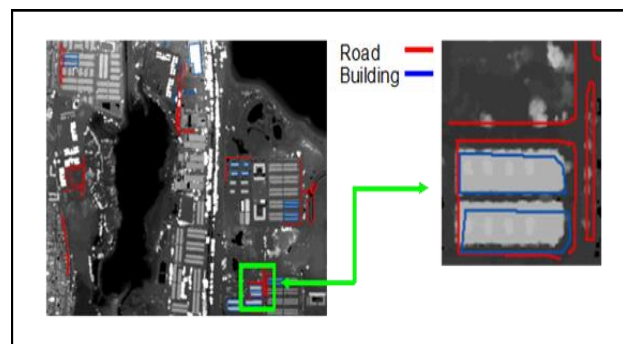

Figure 6. Vector line derived from ground survey overlay with LiDAR DSM plotted at scale 1:10,000 and zoom at scale of 1:2,000

6. DISCUSSION AND FUTURE WORK

6.1 Discussion

In this study, LiDAR DSM and DTM were evaluated quantitatively. The accuracy of LiDAR data depends on many variables. However, accuracies of 0.5 - 1 ft vertical (0.15 m - 0.30 m) generally can be expected for LiDAR data collected from an aircraft. Some of the variables that affect the LiDAR accuracy include atmospheric conditions, GPS control quality, geoid model quality, laser reference frame, scanner angle calibration, grade-break definitions, and percent of leafy foliage covering the ground.

As defined, the equation (1) calculated for the vertical component, shown that the accuracies of the derived models (LiDAR DSM and DTM) are $\pm 0.04\text{m}$ and $\pm 0.01\text{m}$. This accuracy is within the acceptable limit stated by the manufacturer (10-30 cm) which verifies the findings reported by various earlier researchers. For the horizontal component, as defined in equation (2), it is shown that the RMSE_{xy} for LiDAR DSM and DTM are $\pm 0.26\text{m}$ and $\pm 0.32\text{m}$.

It can be concluded that the LiDAR DSM and DTM provides the best horizontal and vertical accuracy on the elevation derived models. This shows that the accuracy of LiDAR dataset is sufficient for topographic map revision for existing topographic map at scale of 1:10,000.

With the stated accuracy, it is expected that LiDAR dataset play an important role in assisting topographic map production where human labour and cost can be extensively reduced. This was proven from the accuracy achieved in this study. LiDAR also can assist in topographic map revision especially for the vertical components (Idris, 2008).

Qualitative assessment in this study is based on the mismatched portrayed between the evaluated dataset such as LiDAR DSM with ground survey dataset. LiDAR DSM provides a high quality above surface data. This is due to features on the LiDAR DSM shown at grayscale based on the height value. Therefore, if the features heights are of the same value with its surrounding height value, such as roads and its surrounding (flat ground), the road features cannot be distinguished. However, outstanding features such as buildings and bridges can be distinguished easily. Further studies towards recognition of features outline from LiDAR dataset and accuracy of orthophoto should be of utmost importance.

7. CONCLUSION

Acquiring 3D topographical datasets using the state-of-the-art laser scanning technology is of great advantage towards various mapping applications in terms of time, cost and accuracy. However, understanding the accuracy for its dataset is a crucial factor in order to appreciate the reliability of its usage.

The experience gained in this study will eventually highlight the future role of this new technology towards the construction of laser scanning Digital Surface Model (DSM) for various applications.

Updated topographic map play an important role in various applications. It shows that, current techniques in map production are time consuming, labour intensive and incurred high cost. With the advent of various mapping technology and the emergence of diversity of dataset, integrating the available dataset seems appealing towards various mapping applications. In this study, it was shown that, the potential of LiDAR DSM dataset has a huge potential towards topographical map revision.

On the other hand, with the advent of LiDAR technology, large areas could be map in a period of short time with high accuracy (Felix, 2015). In Malaysia, LiDAR technology is proven to cater to various land development projects such as the landslide risk assessment in rugged terrain in Sabah (Simard, 2003). The availability of these dataset also seems appealing towards topographical map revision; acceptance of the dataset could eventually enhance the time taken and accuracy of topographical map revision (Hill et al, 2000).

ACKNOWLEDGEMENTS

Many thanks to research and computing facilities were made available by the Department of Surveying Science & Geomatics. Further thanks to Department of Survey and Mapping Malaysia especially all the staff at Data Acquisition Section for their continuous support and guidance in my lab works using TerraScan Software.

REFERENCES

- Ackermann, F., 1997. Airborne laser scanning - a brief status review, Proceedings of 3rd EARSeL Workshop on LIDAR remote sensing of land and sea, (eds.) Babichenko, S. and Reuter, R., Tallinn, Estonia, 17 – 19 July 1997, pp. 85 – 96.
- Akturk, E., & Altunel, A. O. 2019. Accuracy assessment of a low-cost UAV derived digital elevation model (DEM) in a highly broken and vegetated terrain. *Measurement*, 136, 382-386.
- Arcmap. 2019. What is lidar data? Retrieved from <https://desktop.arcgis.com/en/arcmap/10.3/manage-data/las-dataset/what-is-lidar-data-.htm>
- ASPRS, 2005. The 1st draft of the ASPRS Lidar Guidelines on Reporting Horizontal Accuracy.
- Bc-Carms, 2006. LiDAR - Overview of Technology, Applications, Market Features & Industry. Centre for Applied Remote Sensing, Modelling and Simulation, University of Victoria, BC. Accessed April 19, 2011 from <http://carms.geog.uvic.ca/documents.html>
- Cardenas-Martinez, A., Canero, F. M., Garcia-Perez, M. A., Guisado-Pintado, E., & Rodriguez-Galiano, V. 2022. Use of Airborne LiDAR data processing tools and algorithms in natural forested areas: A systematic review. *EGU22*, (EGU22-6599).
- Cheng, L., Chen, S., Liu, X., Xu, H., Wu, Y., Li, M., & Chen, Y. 2018. Registration of laser scanning point clouds: A review. *Sensors*, 18(5), 1641.
- Croneborg, L., Saito, K., Matera, M., McKeown, D., & van Aardt, J. 2020. Digital elevation models.

- Esri, 2022. ArcGIS Desktop. Retrieved from <https://www.esri.com/en-us/arcgis/products/arcgis-desktop/overview>
- Felix R. 2015, October 14. Point Density and Point Spacing. Retrieved from [felix.rohrba.ch: http://felix.rohrba.ch/en/2015/point-density-and-pointspacing/](http://felix.rohrba.ch/en/2015/point-density-and-pointspacing/).
- Fennel, J. 2021, October 14. What is a Topographic Map? - Definition & Features. Retrieved from <https://study.com/academy/lesson/what-is-a-topographic-map-definition-features.html>
- Harley J. B., 1975. The accuracy of ordnance survey maps, Ordnance Survey Maps a descriptive manual, The university press Oxford
- Hill, J.M., L.A. Graham, R.J. Hendry, and D. Young, 2000. Wide area topographic mapping and applications using airborne light detection and ranging (LIDAR) technology, *Photogrammetric Engineering & Remote Sensing*, 66(8): 908-x.
- Huang, J., Zhang, X., Xin, Q., Sun, Y., & Zhang, P. 2019. Automatic building extraction from high-resolution aerial images and LiDAR data using gated residual refinement network. *ISPRS journal of photogrammetry and remote sensing*, 151, 91-105.
- Idris, R. 2008. Evaluation of LiDAR DSM for Topographical Maps Revision. Unpublished Master Thesis, Faculty of Architecture, Planning and Surveying, University Technology MARA.
- Idris, R., Latif, Z. A., Hamid, J. R. A., Jaafar, J., & Ahmad, M. Y. 2014, February. Integrating airborne LiDAR data and photographic images towards the construction of 3D building model. In *IOP Conference Series: Earth and Environmental Science* (Vol. 18, No. 1, p. 012049). IOP Publishing.
- Jaafar, J., 2004. Accuracy Estimates for Klang Valley Laser Scanning Datasets. Unpublished Report, Malaysian Centre for Remote Sensing (MACRES).
- Lakshmi, S. E., & Yarrakula, K. 2018. Review and critical analysis on digital elevation models. *GEOFIZIKA*, 35(2), 129-157.
- Liu, M., Sun, X., Shao, Y., & You, Y. 2018, September. Surface Features Classification of Airborne Lidar Data Based on TerraScan. In *International Conference on Geo-Informatics in Sustainable Ecosystem and Society* (pp. 185-190). Springer, Singapore.
- McGaughey, B. June 11, 2018. LIDAR Basics. Retrieved from <http://forsys.cfr.washington.edu/LIDAR/lidar.html#:~:text=LIDAR%20collection%20system%20uses%20a,the%20underside%20of%20an%20aircraft>.
- Mesa-Mingorance, J. L., & Ariza-López, F. J. 2020. Accuracy assessment of digital elevation models (DEMs): A critical review of practices of the past three decades. *Remote Sensing*, 12(16), 2630.
- Okolie, C. J., & Smit, J. L. 2022. A systematic review and meta-analysis of Digital elevation model (DEM) fusion: pre-processing, methods and applications. *ISPRS Journal of Photogrammetry and Remote Sensing*, 188, 1-29.
- Ramli, F., 2018. Personnel Communication, Mapping Section, Computer Assisted Mapping (CAMS), Department of Survey and Mapping Malaysia
- Rodarmel, C., Theiss, H., Johannesen, T. and Samberg, A., 2006. A review of the ASPRS guidelines for the reporting of horizontal and vertical accuracy in lidar data. *International Archives of Photogrammetry, Remote Sensing and Spatial Information Sciences*, 36(1): 6 pages (on CD-ROM).
- Ruijin Ma, 2004. Building Model Reconstruction from LIDAR Data and Aerial Photographs. M.A., The Ohio State University.
- Salach, A., Bakula, K., Pilarska, M., Ostrowski, W., Górski, K., & Kurczyński, Z. 2018. Accuracy assessment of point clouds from LiDAR and dense image matching acquired using the UAV platform for DTM creation. *ISPRS International Journal of Geo-Information*, 7(9), 342.
- Šíma, J. 2003. Geoinformační terminologie pro geodety a kartografy. [Geoinformatic terminology for surveyors and cartographers]. Výzkumný ústav geodetický, topografický a kartografický (VÚGTK), Zdiaby.
- Simard, R., Belanger, P., Mohamed, M. R., Othman, M. A., & Asbi, M. 2003. Airborne LIDAR Surveys-an Economic Technology for Terrain Data Acquisition. In *Proceedings of the Map Asia Conference* (Vol. 2003, pp. 13-15).
- TerraScan. 1999. TerraScan for Microstation user's guide. Terrasolid Limited, Houston, Texas, USA.
- The University of Kansas, 2022. Chapter 3, Section 15. Qualitative Methods to Assess Community Issues. Retrieved from <https://ctb.ku.edu/en/table-of-contents/assessment/assessing-community-needs-and-resources/qualitative-methods/main>
- USGS, 2006. United States National Map Accuracy Standards (1947), http://www.oh.nrcs.usda.gov/natl_map_accuracy.htm US Bureau of the Budget. (1947). United States national map accuracy standards.
- Wasser, L. A. 2020, October 7. The Basics of LiDAR - Light Detection and Ranging - Remote Sensing. Retrieved from <https://www.neonscience.org/resources/learning-hub/tutorials/lidar-basics>
- Zhu, J., Yang, P. F., Li, Y., Xie, Y. Z., & Fu, H. Q. 2022. Accuracy assessment of ICESat-2 ATL08 terrain estimates: A case study in Spain. *Journal of Central South University*, 29(1), 226-238.
- Zolanvari, S. M., Ruano, S., Rana, A., Cummins, A., da Silva, R. E., Rahbar, M., & Smolic, A. 2019. DublinCity: Annotated LiDAR point cloud and its applications. arXiv preprint arXiv:1909.03613.