



Power Management System (PMS) for Containerized Hybrid Mobile Power Source

Nitin Chafekar, Kirti Rathod, Ravindra Khire and J K Biswas

EasyChair preprints are intended for rapid dissemination of research results and are integrated with the rest of EasyChair.

April 8, 2021

POWER MANAGEMENT SYSTEM (PMS) FOR CONTAINERIZED HYBRID MOBILE POWER SOURCE

Nitin Chafekar¹

K. P. Rathod²

R. S. Khire³

J. K. Biswas⁴

*Research & Development Establishment(Engrs),
Defence R&D Orgn, MOD, GOI,
Alandi Road, Dighi P.O.
Pune-411015, India*

nitinchafekar.ni3@gmail.com¹, kirti.rathod47@gmail.com², rskhire@rde.drdo.in³, jkbiswas@gmail.com⁴

Abstract— All the latest & sophisticated Defence / Military equipment (Mobile or Stationary) which are used in field applications have Diesel Generator Set (DGSet) based Power Supply System. As per Government policies & norms, all Diesel Generator based power generating systems are going to be out of production in coming few years. Worldwide initiative has been taken to emphasize and use of more & more renewable energy sources with alternative solutions even in the Defence applications. Hence to meet future power requirements for providing a complete power solution for remote field applications, hybridization of non-conventional and conventional energy sources like PV Solar, Wind, Fuel Cell, DG-set and battery bank is very much required. The main objective of hybridisation is to maximize the benefit of the available renewable energy sources and to minimize the use of conventional energy sources. In recent years, with advancements in renewable energy technologies, Hybrid Energy System has become one of the most significant and promising system for providing reliable power for remote field applications. Power Management System (PMS) is subsystem of Hybrid Energy System to cater and manage the load demand under varying weather conditions from the different energy sources and the storage units in the system. Power Management System manages these powers to cater power requirements for the stand-alone, remote field requirements for long duration. This paper presents and discusses the details of development of Power Management System (PMS), its hardware implementation and test results.

Keywords— Mobile Hybrid Power Generation System (MHPGS), Photovoltaic (PV), Wind Turbine (WT), battery, Diesel Generator (DG), Power Management System (PMS), Fuel Cell (FC)

I. INTRODUCTION

All the latest & sophisticated Defence / Military equipment (Mobile or Stationary) which are used in field applications have Diesel Generator Set (DGSet) based Power Supply System. The Diesel Generating (DG) sets uses fossil fuel. Carrying and storing of huge quantity of diesel & maintenance of DG sets is costing large amount of funds to the Armed Forces et al [1]. As per Government policies & norms, all Diesel Generator based power generating systems are going to be out of production in coming few years. Worldwide initiative has been taken to emphasize and use of more & more renewable energy sources with alternative solutions even in the Defence applications. Hence to meet future power requirements for providing a complete power solution for remote field applications, hybridization of non-conventional and conventional energy

sources like PV Solar, Wind, Fuel Cell, DG-set and battery bank is very much required. The main objective of hybridization is to maximize the benefit of the available renewable energy sources and to minimize the use of conventional energy sources. To overcome this problem, Containerized Hybrid Power Generation System (CHPGS) which is a combination of solar system, wind energy, Fuel cell sources with DG set and batteries is developed as technology demonstrator. Power Management System (PMS) is subsystem of Hybrid Energy System to cater and manage the load demand under varying weather conditions from the different energy sources and the storage units in the system. Power Management System manages these powers to cater power requirements for the stand-alone, remote field requirements for long duration. Power Management System (PMS) manages these conventional & non-conventional energy sources. It achieves the switching control among the sources (overall monitoring, controlling and prioritization) in order to satisfy the load requirements throughout the whole operation period et al [2] The Use of Power Management System can make Containerized Hybrid Power Generation System (CHPGS) as a controlled electricity generation and storage system which enables an economical and environment friendly system to supply continuous electricity as per load demand. In order to have an inside exposure and better understanding of topologies & their control logic, the developmental work for hardware of Power Management system was taken up as a proof of concept. This Power Management System is an important sub system of hybrid mobile power supply. The testing was carried out on the hardware to analyze, monitor the electrical parameters, transient behavior by simulating various conditions.

II. SYSTEM DESCRIPTIONS

Power Management System takes input power from multiple sources and supervise the overall operation of Hybrid Power System to maximize and optimize the output of available non-conventional energy resources. Hence hardware of Power Management system was designed to handle multiple energy sources and control the power distribution among the conventional & non-conventional power sources thus increasing the reliability and power quality of the Containerized Hybrid Power System. Power Management System also manages the power flow of battery to fulfill the load demand, i.e. (It controls

the charging/discharging of the battery bank). Hybrid power generation system needs, Power Management System to control the proper active power flow from and to the battery storage system. The combination of hybrid system with battery and efficient Power Management System makes the best use of the advantages of each power generating system. If the load demand changes, then power supplied by the hybrid system should change accordingly. The PMS automatically adjusts power distribution among the available power sources like Photo Voltaic (Solar) Panels, Wind Turbine, Fuel Cell system, batteries etc. In case of non-availability / less power from non-conventional power sources, PMS caters load demand using Batteries & Fuel Cell. In case of non-availability / less power from batteries & fuel cell, PMS caters load demand by switching ON the Diesel Generator Set which in turn charges the discharged batteries.

In this design the photovoltaic, wind energy & battery sources are utilized as leading sources. The fuel cell (FC) provides power in case of non-availability / less power from of photovoltaic, wind energy & battery sources. The ultra-capacitor (UC) can be utilized in addition to battery bank as a buffer storage to compensate the slow dynamic response of the Fuel Cell /Battery Bank during transient power demand and regulate the DC-bus voltage. The power control strategy has been designed to work into two stages. The stage 1 controls the entire power management, which generates references to individual subsystems depending upon solar radiation, temperature, and load conditions. Based on the command signals, each local controller controls the Photo Voltaic, Wind Turbine, Fuel Cell, and Ultra Capacitor. The Power Management System shall confirm a continuous working of the hybrid system through the coordination of all energy sources, energy storage systems and load. Figure 1 to 3 depicts the tentative pen picture of functioning, role and interfacing of Power management System with other system.

III. OVERALL SYSTEM BLOCK DIAGRAM

The basic block diagram of Power management systems is shown at Figure 1 with all interconnected resources like Solar, Wind, Fuel cell and DG set. Photo Voltaic array and Wind Turbine have their individual charge controllers. Fuel Cell provides DC output. Diesel Generator set is connected to Power management System via AC to DC converter. All the energy generating sources are connected in parallel to the bus bar of Power Management System.

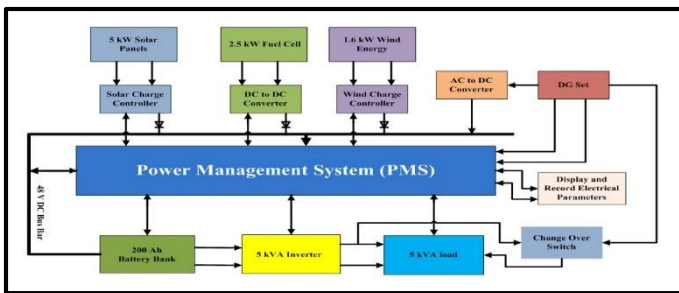

Figure 1: Power Flow Diagram of Power Management System For Containerized Hybrid Power Generation

Figure 2 shows the Interfacing Block Diagram of solar panels with Power Management System and other sub systems. It can be seen from the figure that there are total 18 numbers of polycrystalline Solar Panels of capacity 315 watt each, two of them are connected in series and 9 such strings are connected in parallel to each other. A 5 kW Solar Charge Controller i.e. (DC to DC converter) is connected to the output of looped polycrystalline solar panels. This is further connected to Power Management System. With the help of potential divider and using shunt resistor, Power Management System measures the voltage & current values of solar charge controller and displays these values on 10” screen. It can further manages the flow of power depending upon the priority based requirements.

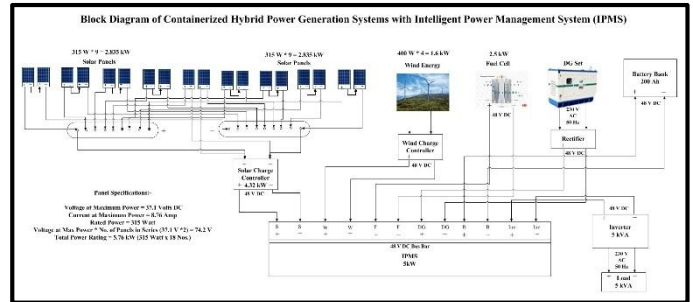

Figure 2: Interfacing Block Diagram of Solar Panels with Power Management System and other Sub System

IV. SYSTEM DESIGN

The wiring diagram of Power Management System is shown in Figure 3. There are four signal conditioning cards for Solar Panels, Wind Turbines, Batteries & Fuel Cell et al Protecting Power Diodes are connected at the input positive side of the signal conditioning card to prevent reverse currents among the available power sources through the 48 volt DC Bus bar. At the input negative terminals, shunts are connected to sense the current parameters and issuing the signal to the corresponding analog to digital converter (ADC) cards. Analog to Digital Converter further gives the signal to the Raspberry Pi 3B Microcontroller which is the heart of the Power Management System for displaying these values on Liquid Crystal Display (LCD) of Power Management System. The algorithms are written in Python. The Power Management System gives signal to relay logic card for operation of two numbers of relays (12 V, 100 Amp). One relay connects Fuel Cell output to DC Bus Bar in case of non-availability / less power from the Solar Panels & Wind Turbines. The other relay switch ON the DG set to charge the discharged batteries & provide power to the load in case non-availability of power from all other sources. Power management system is a smart system and it can provide a priority based solution to the containerized hybrid power generation system. The fuel cell will be automatically turn ON when the battery voltage goes at the level of 42 V. DG set will be automatically ON when voltage goes down at 40 V.

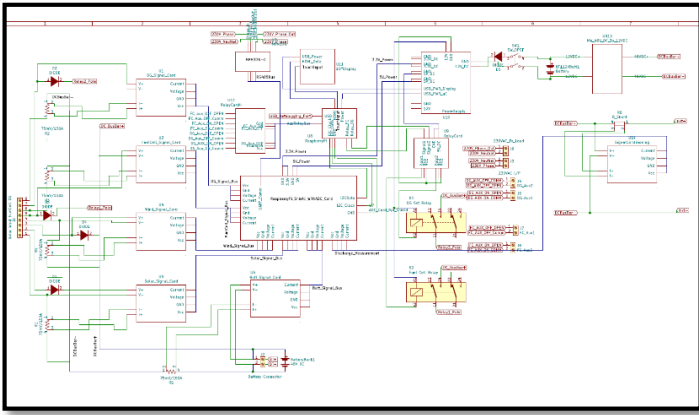

Figure 3: Block Schematic of Power Management System with connection points and internal parts

V. HARDWARE TESTING RESULTS

Based on the above details, the hardware of Power Management System was developed. Prior to testing all the physical checks was conducted covering internal circuitry, MMI, various Input / Output ports etc. For testing, simulated DC loads were created using the resistive Load Banks. AC loads were used for testing using inductive load banks. For simulating various input sources the 48 V DC Battery bank was used. The Power Management System has 48 V DC Bus Bar. A separate Lithium ION battery is used to power the control circuit of Power Management System. This battery is charged from 48 Volt DC Bus Bar using a DC to DC converter. This internal battery gives back up approximately for 2 to 3 hrs. The load is connected to the Inverter via Power Management System and further various AC loads were connected as explained in. Prior to testing, calibration of each signal conditioning card was carried out and test results are given in succeeding paragraph. For checking the DG Set / Fuel cell conditions, one of the batteries from the battery set was disconnected by creating low DC voltage. Two connections are provided on the Power Management System for DG set and Fuel cell ON / OFF. The DG set was connected and it's on and off condition was checked by simulating battery low around 40 V approx. with loaded condition. Same procedure was carried out for Fuel Cell operation condition. The PMS also can store the voltage & current parameters of all available energy sources as well as the load. An USB port is provided on the PMS to log this data on pen drive. This data can be used for further analysis. The Data logging activity was also checked. All the electrical parameters like line AC Voltage & Current with DC Bus Voltage & Current were monitored and checked. After simulated test the Power Management System was connected with actual sources like solar PV system, wind via their charge controllers. An Inverter was connected via Power Management System and actual AC load was connected. All the electrical parameters line AC Voltage, Current with DC Bus Voltage / Current were monitored, checked & logged. All the electrical parameters for active power sources were also monitored and measured.

The data logging was also checked by connecting the USB at Power Management System port and log data was checked is devised in.

A. FLOW CHART OF THE SYSTEM

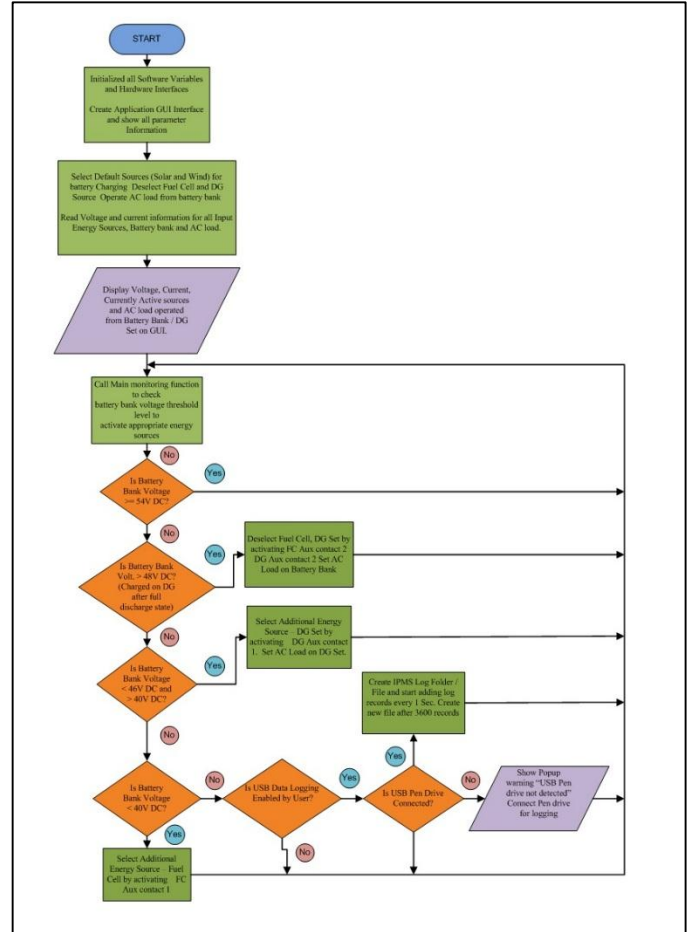

Flow Chart 1: Detailed Flow Chart of Power Management System (PMS) for Containerized Hybrid Mobile Power Source

B. BATTERY BACKUP TEST DATA USING POWER MANAGEMENT SYSTEM

As explained in power flow diagram, a battery bank is a very important subsystem in Containerized Hybrid Power Generation System (CHPGS) which stores the energy from various sources. 48 V, 200 Ah lithium ion battery bank has been used and is mounted in the Containerized Hybrid Power Generation System. This is interfaced to Power Management System via DC Bus Bar. The battery backup test was also conducted and it is observed that initially the battery was full state of charge (SOC) after putting the load of 2.5 kW on it, the battery gives backup for around 2 hrs. 48 min for 75 % usage of battery bank. From the above observation the battery capacity is more enough sufficient to delivered the desired power to the load through Power Management System at critical condition

and the electrical parameters data is automatically monitored and stored in the USB drive by the help of Power Management System. Figure 4 depicts the battery management data using power management System

Sr. No.	Time (Hrs:Min)	Battery Voltage (V)	Battery Current (Amp)	AC Load Voltage (V)	AC Load Current (Amp)	AC Load Power (kW)	Battery 1 SOC	Battery 2 SOC
1.	10:45	51.4 V	0.00 A	0 V	0 A	0 kW	100 %	100 %
2.	10:50	48.7 V	61.8 A	229 V	11.12 A	2.5 kW	<100 %	<100 %
3.	11:30	48.3 V	63.0 A	229 V	11.18 A	2.56 kW	<100 %	<100 %
4.	12:00	48.1 V	63.9 A	229 V	11.18 A	2.56 kW	75 %	75 %
5.	12:30	48.0 V	63.5 A	229 V	11.18 A	2.56 kW	50 %	50 %
6.	13:00	47.8 V	64.1 A	229 V	11.18 A	2.56 kW	<50 %	<50 %
7.	13:30	47.2 V	64.9 A	229 V	11.12 A	2.54 kW	25 %	25 %

Table 1: Battery Backup Data using Power Management System

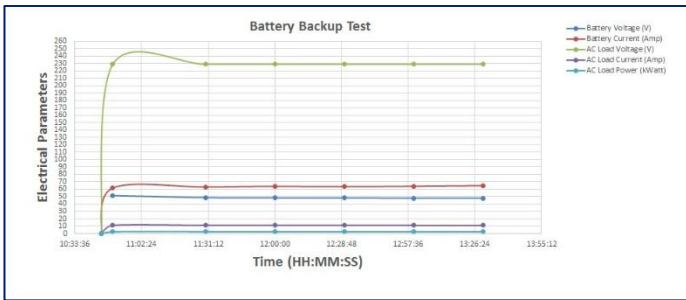

Figure 4 : Battery Backup Data using Power Management System

D ELECTRICAL POWER OF EACH SYSTEMS USING POWER MANAGEMENT SYSTEM

The integrated testing was also carried for the complete system with Power Management System. Table 2 depicts the performance evaluations of solar PV in the containerized Hybrid Power Generation System with Power Management System. At the peak hours, solar panels generate maximum power and has maximum share of the power to the load. At each stages from generation to load distribution, the Power Management System monitors & controls the power flow of each sub system and gives the standardize voltage levels along with protection. The Figure 5 shows the GUI of Power Management System. Figure 6 represents performance evaluation and testing of containerized hybrid power generation system using power management systems.

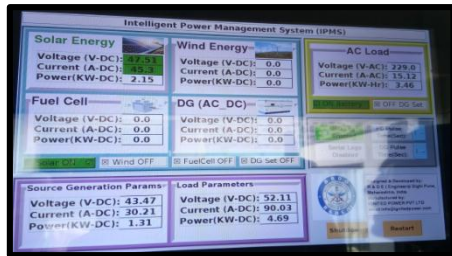

Figure 5: GUI of Power Management System

Time (Hr:Min)	Solar Voltage (Volts)	Solar Current (Amp(s))	Solar Power output (kW)	SGP Voltage Volt(s)	SGP Current Amp(s)	SGP Power (kW)	Inverter input Voltage Volt(s)	Inverter input Current Amp(s)	Inverter input Power (kW)	AC Load Volt(s)	AC Load Amp(s)	AC Power (kW)
10:30	37.4	12.58	0.5	31.97	23.42	0.75	43.67	86.29	3.76	214	16.5	3.59
10:40	37.52	19.41	0.75	32.18	27.84	0.91	44.08	88.16	4.19	214	16.62	3.59
10:50	38.82	21.21	0.83	32.39	28.18	0.95	44.08	94.39	4.23	214	16.62	3.6
11:00	38.86	22.29	0.97	32.39	30.21	0.98	44.08	95.02	4.23	214	16.62	3.6
11:10	39.2	24.44	1.05	32.6	30.89	1.04	44.49	95.64	4.24	214	16.75	3.6
11:20	39.87	25.88	1.06	32.6	31.23	1.04	44.7	95.64	4.41	214	18	3.79
11:30	40.32	26.6	1.07	33.44	31.57	1.05	45.52	95.95	4.43	214	18	3.79
11:40	40.4	29.12	1.09	33.64	32.59	1.05	45.52	96.58	4.45	214	18	3.79
11:50	40.4	29.48	1.24	33.64	32.93	1.07	45.73	96.58	4.45	214	18	3.79
12:00	40.46	32.35	1.32	33.85	32.93	1.14	45.93	97.51	4.46	215	18	3.79
12:10	40.95	33.07	1.38	33.85	33.27	1.14	46.14	97.51	4.49	215	18	3.79
12:20	41.03	34.87	1.38	33.85	33.61	1.14	46.14	97.82	4.49	215	18	3.81
12:30	41.29	35.59	1.4	33.85	33.95	1.16	46.14	97.82	4.54	215	18	3.81
12:40	41.58	37.03	1.4	33.85	34.29	1.17	46.35	97.82	4.54	215	18	3.81
12:50	41.58	38.47	1.59	34.06	34.63	1.17	46.35	97.82	4.54	215	18	3.81
13:00	41.66	38.47	1.62	34.06	34.63	1.18	46.55	98.13	4.58	215	18	3.81
13:10	42.29	38.83	1.63	34.27	34.63	1.2	46.55	98.13	4.59	215	18	3.81
13:40	42.33	38.83	1.65	34.48	34.97	1.21	46.96	98.13	4.6	215	18	3.81
13:50	42.62	38.83	1.65	34.69	35.31	1.21	46.96	98.44	4.6	215	18	3.81
14:00	42.62	39.19	1.67	34.9	35.65	1.24	46.96	98.44	4.62	215	18	3.81
14:10	43.35	39.19	1.69	35.32	35.65	1.26	47.17	98.44	4.66	216	18	3.81
14:20	43.08	40.26	1.7	35.32	35.99	1.27	47.17	99.07	4.66	216	18	3.82
14:30	43.12	40.26	1.71	35.94	35.99	1.28	47.17	100.31	4.66	216	18	3.82
14:40	43.17	42.06	1.75	35.94	37.01	1.29	47.58	100.63	4.67	216	18	3.82
14:50	43.25	42.06	1.75	36.15	37.01	1.31	47.58	102.49	4.68	220	18.12	3.82

Table 2: Performance Evaluation and Testing of containerized Hybrid Power Generation System using Power Management System

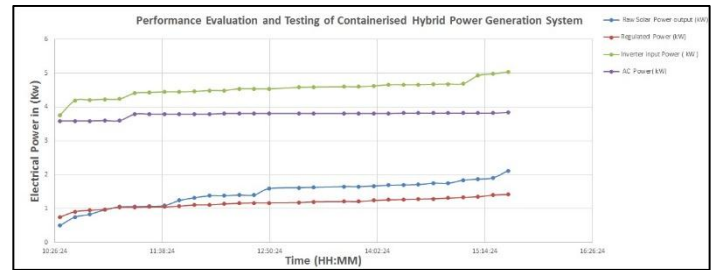

Figure 6: Performance Evaluation and Testing of containerized Hybrid Power Generation System using Power Management System

VI. CONCLUSION

Power Management System is playing a vital role in Containerized Hybrid Power Generation Systems (CHPGs). Power management system is an important subsystem to assure economical and efficient use of CHPGS. Variable weather conditions, day-night conditions, and rapid change in voltages of non-conventional energy sources make this necessary. Power management can be achieved by using maximum power point tracking (MPPT) devices in order to determine the most efficient operating point of a system in a particular weather condition and by switching available power sources so that they actively support each other to cater the variable load requirements. The hardware development of a Power management system for maintaining the energy sustainability in renewable energy systems is presented in this paper. Performance tests have been carried out on this system to verify the functionality and to validate its worthiness. This developed hardware has been tested using experimental prototypes of hybrid power generation system. Based on the results of testing, it is seen that similar systems with required modifications can be designed for various applications for military uses to fulfill the power supply requirements at remote locations.

VII. Acknowledgment

The authors wish to thank Shri.V V Parlikar Director, Research and Development Establishment (Engrs.), Alandi Road, Dighi, Pune-411015 for constant encouragement and valuable guidance

to publish this paper. Thanks to the entire design team for their valuable suggestions and support.

References

- [1] Tapan Shah, Zeeshan Ahmad Ansari “An Overview of Intelligent Energy Management System for DC Microgrid: System and Communication Architecture and Application in Power Distribution System” 2018 IEEE 13th International Conference on Industrial and Information Systems (ICIIS).
- [2] Anjali Gupta and Anjali Jain “Intelligent Control of Hybrid Power Systems for Load Balancing and Levelised Cost” 1st IEEE International Conference on Power Electronics, Intelligent Control and Energy Systems (ICPEICES-2016).
- [3] Bruno Belvedre “A microcontroller Based Power Management System for Standalone Microgrids with Hybrid Power Supply” 2012 IEEE Transactions on Sustainable Energy.
- [4] Md. Aminul Islam “Power Management Strategy for Solar –Wind –Diesel Standalone Hybrid Energy System” 2014 International Journal of Electrical, Computer, Electronics and Communication Engineering.
- [5] J.Godson “Solar PV-Wind Hybrid Power Generation System” 2013 International Journal of Advanced Research in Electrical Electronics and Instrumentation Engineering.
- [6] Rashid Al Badwawi “A Review of Hybrid Solar PV and Wind Energy System” 2015 Smart Science.
- [7] B. Vishnu Priya “Power Management Strategies for a Grid Connected PV-FC Hybrid Systems” 2012 International Journal of Engineering Research & Technology.
- [8] Jayeshkumar G. Priolkar “Management & Control of Hybrid Power System” 2015 IEEE Sponsored 2nd International Conference on Innovations In Information Embedded and Communication Systems.