



## Consumer and Prosumer Comparative Statistical Analysis of Load Curves. Study Case: Romania

---

Ioan Tiberiu Serban, Stefan Sontea, Valentina Rohat,  
Tudor Catalin Sava, Ion Murgescu, Bogdan Onose and  
Ioan Bitir-Istrate

EasyChair preprints are intended for rapid  
dissemination of research results and are  
integrated with the rest of EasyChair.

July 8, 2021

# CONSUMER AND PROSUMER COMPARATIVE STATISTICAL ANALYSIS OF LOAD CURVES. STUDY CASE: ROMANIA

1<sup>th</sup> Serban Ioan Tiberiu  
INCDIE ICPE-CA & University  
Politehnica of Bucharest  
Bucharest/Romania  
tibisav@yahoo.com

2<sup>th</sup> Stefan Sontea  
INCDIE ICPE-CA & Wallachian  
University of Targoviste  
Targoviste/Romania  
ssontea@yahoo.com

3<sup>th</sup> Valentina Rohat  
University Politehnica Of Bucharest  
Bucharest/Romania  
rohatvalentina@yahoo.ro

4<sup>th</sup> Sava Tudor Catalin  
University Politehnica of Bucharest  
Bucharest/Romania  
savatudorcatalin@yahoo.ro

5<sup>th</sup> Murgescu Ion  
INCDIE ICPE-CA  
Bucharest/Romania  
ion.murgescu@icpe-ca.ro

6<sup>th</sup> Onose Bogdan  
INCDIE ICPE-CA  
Bucharest/Romania  
bogdan.onose@icpe-ca.ro

7<sup>th</sup> Bitir Istrate Ioan  
University Politehnica Of Bucharest  
Bucharest/Romania  
ioanistrate2005@yahoo.com

**Abstract** - The issue of the atmosphere gases concentration decrease, generated by the human activities, was the key point for integrating renewable energy sources into the electricity grid. Thus, consumers became prosumers, allowing energy consumers not only to use, but also to generate energy, the surplus being sold on the electrical network. The support of prosumers in the countries of the European Union has registered significant growth rates, especially regarding the energy produced from photovoltaic panels in households or in commercial spaces. Romania will promote the distributed generation from renewable sources with installed power between 3 kW and 100 kW (most recently, starting from 4<sup>th</sup> of December 2020), the on-grid installations being subsidized through the financial support of the Environmental Fund Administration (3 kW for residential prosumers) with „photovoltaic green house,, program and Ministry of Economy, Energy and Business Environment with the „Electric Up,, program ( between 27 kW - 100 kW power for commercial prosumers). This paper proposes an analysis of a Romanian prosumers with a specific case study, comprise of a comparative analysis for an integrated 3kW (residential) energy user versus a smart prosumer, and their subsequent energy curves, in order to reduce the energy consumption with a management system for the optimal coordination of the energy to the owner's need, also the rentability of the system and a minimum disturbance of the electricity grid.

**Keywords:** consumer, energy, grid, prosumer, photovoltaic panels, smart grid

## I. INTRODUCTION

For decades, the production, transmission and distribution of electricity have been components of monopolistic systems, vertically integrated and centrally controlled. High power production units, of thermal, nuclear or hydraulic, ensured the production of electricity according to a single criterion: the order of merit. In such a system the control and command were performed centrally and hierarchically [1-5]. In present, energy systems are undergoing profound transformations [6-12], mainly due to the deregulation and opening of energy markets. During several stages, we passed successively from the monopolistic structure characterized by the existence of a single owner (the state) to the competition situation characterized by the existence of several actors of more or less important size. The prospect of depleting non-renewable primary energy resources (fossil fuels) and the threat of climate change and environmental degradation have had the effect of mobilizing the international community to mitigate the negative consequences of these effects. The problem of stopping the increase in the concentration of greenhouse gases in the atmosphere, generated by human activities, has been the key point of several international meetings.

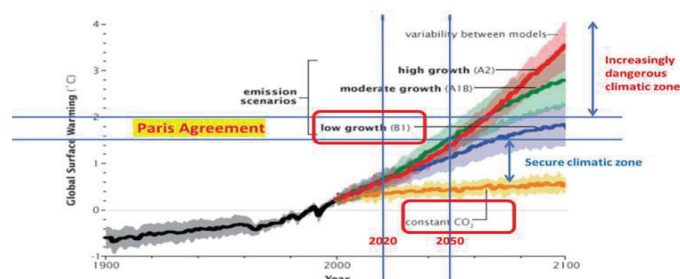

Fig. 1 Simulation of global warming evolution

With the increase in the share of consumers using distributed electricity production systems based on photovoltaic panels, [13-19] smart meters, household battery storage systems, electric mobility and, in general, smart energy consumption devices, there will be important transformations of the way electricity is distributed [20-25],[31],[32]. The prosumer is not a simple consumer of energy, but also an energy producer who is having the possibility to optimize the moment of consumption, respectively to inject energy form their own production in the network according to the instantaneous price of energy, can change the profile of the curve load by flattening the tips and raising the gaps. In this way, the prosumer can contribute to the integration of intermittent renewable energy sources production in the National Energy System, reducing balancing costs. The new updated renewable energy sources promotion directive (EC 2016b) proposes to guarantee the right of individual consumers and local communities to become prosumers and to be remunerated for the energy delivered in the network, as well as other mechanisms that facilitate this transition. For example, consumers will have the right to request from the supplier a smart meter and a contract with a dynamic price, which will allow them to adapt their consumption to the variation of the price of electricity.

The increase in the number of prosumers was facilitated by the decrease of the costs of renewable electricity production technologies, especially the production of photovoltaic panels (0.3 \$ /watt).

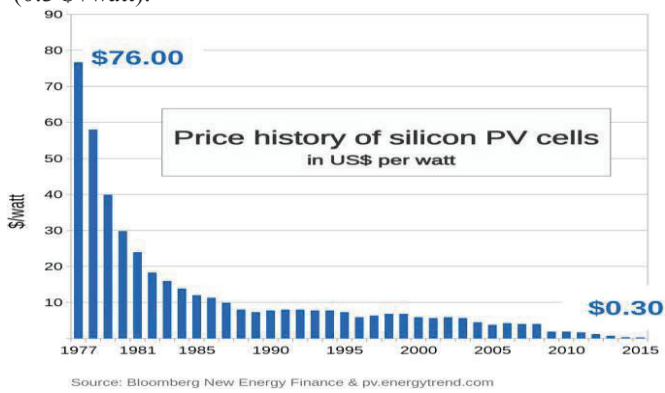

Fig. 2 Evolution of price for PV panels [ 29 ]

Romania will promote the prosumers through the 2 programs: photovoltaic green house and Electric Up and with it will increase the power installed of the photovoltaic by maximum 14 percent ( 100 MW - 200 MW), curently installed which is 1400 MW .

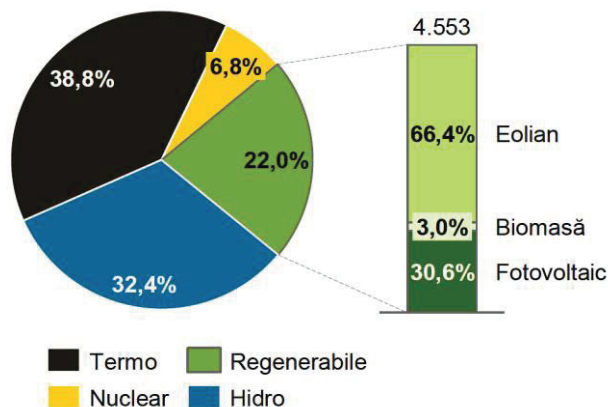

Fig. 3 RES-based generation in Romania (MW) at the end of 2019 [ 22 ]

Romania has also a 3.4 million individual homes potential, that may become prosumers which is 10.2 GW (3kW each individual house).

Worldwide energy consumption is expected to increase by 50 percent form today to 2045. The transformation of a traditional city into a smart city is not a simple task and requires from start a correct management of energy, which leads to energy efficiency through the sustainable behavior of prosumers. Thanks to new technologies such as IoT and smart appliances (Control Home Management, CHM), it is possible to induce to the consumer a new type of behavior, not only regarding the energy consumption, but also the exchange and sale of energy, assuming a fundamental role in Smart Grids.

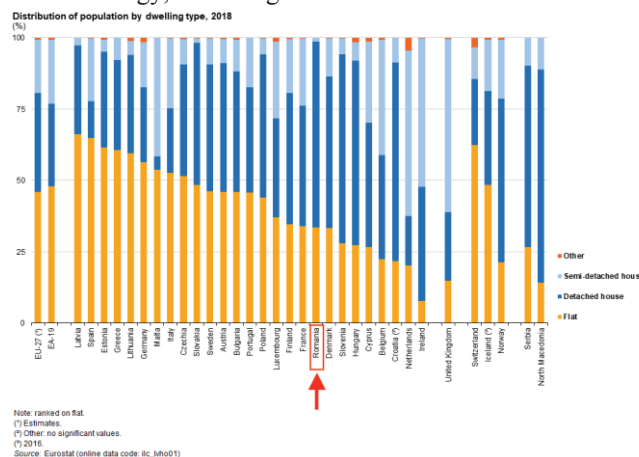

Fig. 4 Distribution of population by dwelling type ( Romania is marked in red ) [ 27 ]

Generating electricity with photovoltaic solar panels is a viable solution in all regions of Romania both for independent photovoltaic systems and for the construction of photovoltaic plants connected to the national energy system. Romania is privileged in terms of solar energy, the level of solar irradiance being higher than in Western European countries with a tradition in using these systems.

The installation criteria of prosumer is influenced by different factors: technical, economic, environmental and socio-political.

## II. RESEARCH

### A. User site presentation

Following the analysis of several initial locations, the North Dobrogea area (Isaccea, Tulcea County, latitude 45.275, longitude 28.453) was selected as the optimal position in terms of solar irradiation and climatic conditions in Romania for the configuration of the residential photovoltaic system (prosumer). The user has a building consisting of a PVC container of approximately 26m<sup>2</sup> with 2 benders (terraces) on one side in the northeast direction and on the other in the southwest direction, in total being an area of 70m<sup>2</sup>. Both are with a roof in a „water form,, inclined at 30 degrees.

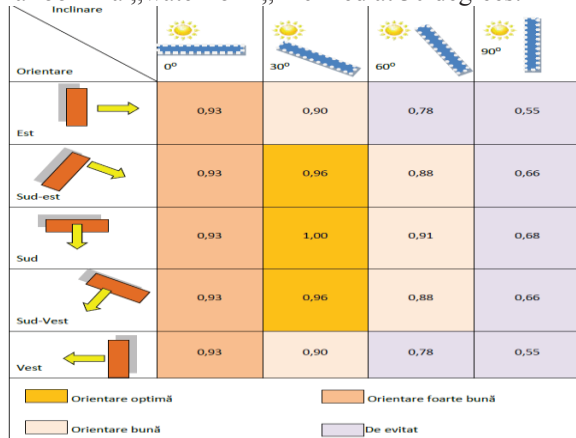

Fig.5 Orientation and inclination factors [ 30 ]

### B. Photovoltaic system analysis

The photovoltaic system will be located on the south-south / west side. The benefits of the photovoltaic system depend to a large extent on the orientation and inclination of the photovoltaic modules, the optimal orientation being south / southwest and an inclination of 30 degrees as the location on the roof is 30% more efficient than those on facades. At the same time, this user benefits from the financial support of the Environmental Fund Administration.

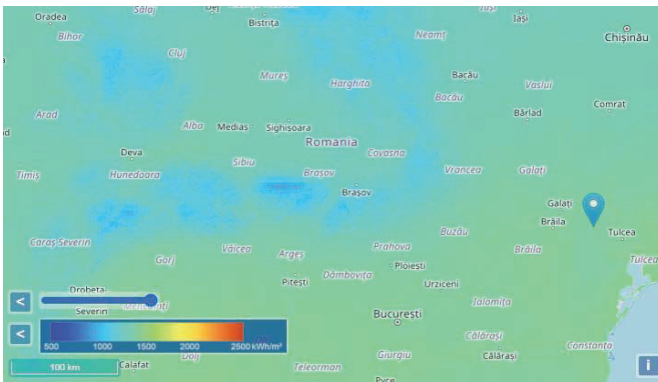

Fig. 6 Solar irradiation [kWh/m<sup>2</sup>] in Romania and the location of the selected prosumer [ 26 ]

Solar irradiation was measured directly, using pyranometers or photovoltaic sensors or indirectly by analyzing satellite images during a year and also with a wattmeter (fig. 7 ) household applications used by the user/consumer to measure electricity consumption/hour to establish the paradigm of consumption per day/month/season for its further improvement, implicitly energy efficiency. Also it was use to see the difference between data sheet given by the manufacturer of the household application and the measurement itself.



Fig. 7 Wattmeter

The estimated consumption with standard electrical equipment without electric heating, in a house in Romania is between 200kWh-300kWh /month (in this case season, for a family with 3-4 members in which the maximum electricity consumption is in the morning and evening). On average, in this type of house, the photovoltaic energy produced per day is consumed below 20% (around 15%), the rest being injected in the network (85%). It will be higher if we have a higher consumption during the day (11-15 hours) when the Sun is at its highest level, a situation in which the energy consumed from the photovoltaic installation that will be sold in the national grid will be equal or exceed the value of own consumption. The price of energy in Romania today is 65% higher than if the energy were sold in the network. (0.68 lei / kWh compared to 0.22 lei / kWh).

The price of energy in Romania today is 65% higher than if the energy were sold in the network. (0.7 lei / kWh compared to 0.22 lei / kWh).

The residential consumer will be with the following household applications having the following installed powers and operating times depending on the season. In late spring, summer and early autumn, air conditioning for cooling will be taken into account.

Household applications are:

1. TV with a consumption of 153 kWh / year but by the manufacturer.
2. 12000BTU air conditioning with a consumption of 8-9 kWh / day in the hot season
3. Refrigerator with a consumption of 219 kWh / year ( not a constant load ).
4. Led lamps (8) with a total of 80W



5. Laptop is charged 2h / day resulting in 0.066kWh / day or 24kWh / year (fig.8)
6. 80 liter electric boiler with a consumption of 2.8-3 kWh / day
7. Washing machine on a washing cycle consumption 600W (1 / 2h)
8. Electric hob (1500W) / Electric toaster (750W)



Fig. 8 Example of measuring consumer energy ( laptop ) in an hour

The user's 3kW photovoltaic system:

- 10 mono-crystalline panels for a higher efficiency (up to 18% compared to 14-15% polycrystalline) with an individual power of  $300W_p = 3kW$  inclined at 30 degrees, facing SW
  - an inverter with range between 90-500V (because the system has a voltage of 320V and a current of 9.2A)
  - connection materials;
  - mode of communication;
  - intelligent meter that measures the amount of energy produced by the photovoltaic panel system and that allows the collection and transmission of relevant data remotely, in electronic format;
  - direct current / alternating current electrical panel;
  - assembly structure; possibly batteries;
- The connection is single-phase with an amperage of 13A, with a copper cable with a nominal section of the conductor of  $2.5mm^2$ .

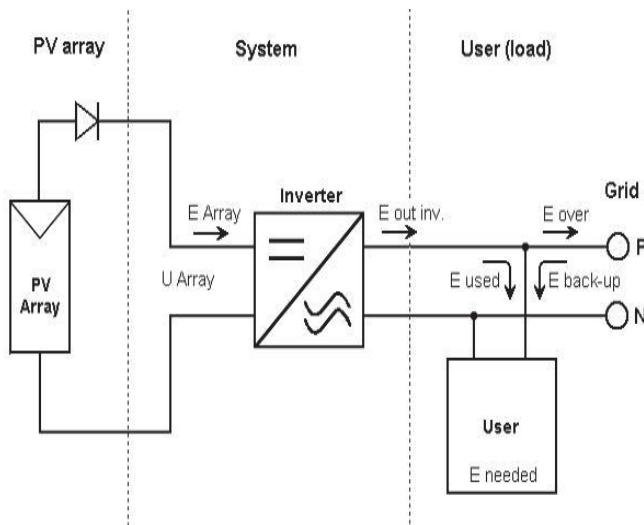

Fig. 9 Prosumer scheme (classic) [ 21 ]

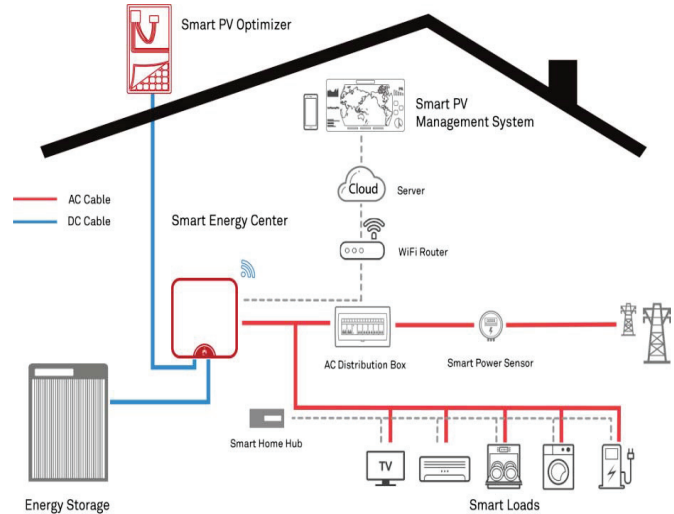

Fig. 10 Intelligent on-grid photovoltaic system [ 28 ]

Intelligent photovoltaic systems are digital systems with microprocessors that control, via IoT or radio, household consumers, energy storage, grid injection, remotely transmit the values of consumption and instantaneous production, analyze them for predetermined periods, optimize the power of the PV panel area, all in order to maximize profit and streamline consumption.

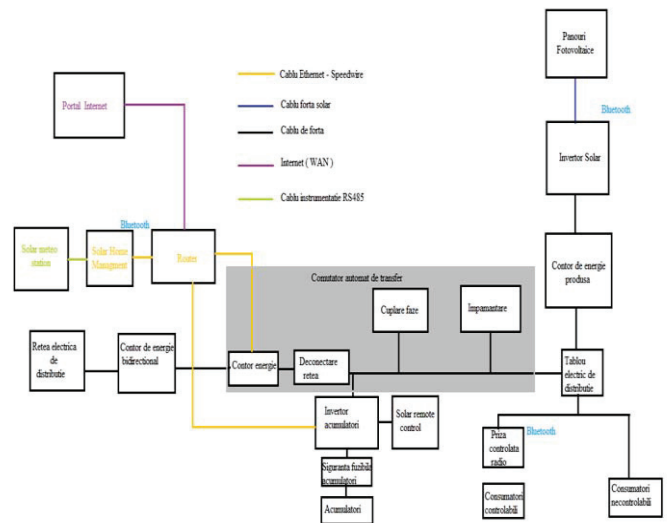

Fig. 11 Flexible system with 3-phase on-grid coupling with load management ( with battery back-up ) - concept

Through the INTERNET PORTAL, the CHM offers various facilities for load control, such as information on the current state, energy balances, forecasts for photovoltaic (PV)

generation, and recommended actions based on them. In addition, the CHM can control tasks automatically if they are connected to an interface with proper communication. CHM together with radio controlled sockets form the core of the basic solution for intelligent energy management and offers the following functions of creating PV production forecasts, creating load consumption profiles, data transmission to the INTERNET PORTAL, limiting the injected active power if necessary, automatic control of consumers through Radio controlled sockets.

Compared to the above system, it has the advantage of connecting to the three-phase network and storing electricity in accumulator batteries.

**III. PHOTOVOLTAIC PANEL MEASUREMENT**

The mono-crystalline photovoltaic panels were measured in the laboratory using the Pasan Highlight solar simulator (several in Europe) which is designed to test, evaluate and determine the operating parameters of photovoltaic modules. They were measured to certify the data given by the manufacturer. The value of a panel was: 296 W, with 1.5% loss of the rated value (300W).



Fig. 12 300W crystalline photovoltaic panel measurement

The equipment is tester module type composed of:

- Flash generator, which is the power supply of the light source



Fig. 13 Flash generator

- Flash lamp separated by two tubes, generating a calibrated light pulse;
- Electronic load, which scans the tested device (DUT) response to the UI curve during the light pulse;
- Control and monitoring cells that allow to control and measure the effective light of irradiation;
- A temperature measurement, which is included in the monitor cell, but which can also be independent (as an option);
- Computing unit with Pasan software for calculating and storing measured data;

Functional Parameters:

- Generator module: includes power source (capacitors) and control electronics for the light pulse emitted by the flash box. Maximum voltage: 800V, cycle: 30s.



Fig. 14 System's Generator Module

- Flash box: emits light pulse due to xenon lamps. It is connected to the generator module by a high voltage cable.



Fig. 15 Flash box



Fig. 16 Preparation for measuring monocrystalline photovoltaic panel

**IV. SIMULATION**

### A. Classical prosumer analysis

In the classical system, the energy production from the photovoltaic system is consumed so far as there are household applications in function at the moment of its production.

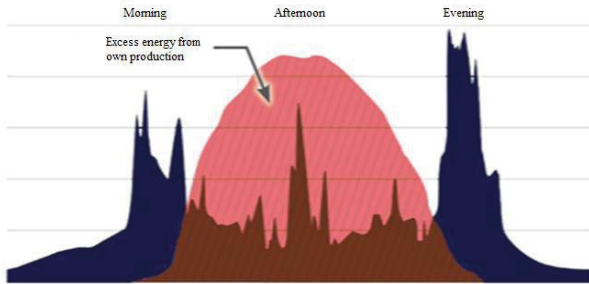

Fig. 17 Energy curve (classic system)

The user has the following households consumers as we previous specified in this paper with following installed powers and operating times depending on the month and season. These are distributed according the user's needs. During the warm season (May, June, July, August, September) a limited air will be taken into account to cool the room.

TABLE I

Household consumers and their energy distributed per months

January and February									
	Number	Power	Use	Energy	Number	Power	Use	Energy	
Lamp Led	8	15 W/lamp	11 h/day	1320 Wh/day	8	15 W/lamp	1320 h/day	1320 Wh/day	
TV/PC/Mobil	2	150 W/app	4 h/day	1200 Wh/day	2	150 W/app	1200 h/day	1200 Wh/day	
Frigider	1		24 Wh/day	581 Wh/day	1		24 Wh/day	581 Wh/day	
Masina de spalut	1		1 Wh/day	1200 Wh/day	1		1 Wh/day	1200 Wh/day	
Plita electrica/Prajitor paine/Sistem audio	1	1000 W tot	1 h/day	1000 Wh/day	1	1000 W tot	1000 h/day	1000 Wh/day	
Boiler electric	1	2000 W tot	2 h/day	4000 Wh/day	1	2000 W tot	4000 h/day	4000 Wh/day	
Stand-by consumers			24 h/day	240 Wh/day			24 h/day	240 Wh/day	
<b>Total daily energy</b>				<b>9541 Wh/day</b>				<b>9541 Wh/day</b>	

March and April									
	Number	Power	Use	Energy	Number	Power	Use	Energy	
Lamp Led	8	15 W/lamp	6 h/day	960 Wh/day	8	15 W/lamp	720 h/day	720 Wh/day	
TV/PC/Mobil	2	150 W/app	4 h/day	1200 Wh/day	2	150 W/app	1200 h/day	1200 Wh/day	
Frigider	1		24 Wh/day	581 Wh/day	1		24 Wh/day	581 Wh/day	
Masina de spalut	1		1 Wh/day	1200 Wh/day	1		1 Wh/day	1200 Wh/day	
Plita electrica/Prajitor paine/Sistem audio	1	1000 W tot	1 h/day	1000 Wh/day	1	1000 W tot	1000 h/day	1000 Wh/day	
Boiler electric	1	2000 W tot	2 h/day	4000 Wh/day	1	2000 W tot	4000 h/day	4000 Wh/day	
Stand-by consumers			24 h/day	240 Wh/day			24 h/day	240 Wh/day	
<b>Total daily energy</b>				<b>9181 Wh/day</b>				<b>9181 Wh/day</b>	

May and June									
	Number	Power	Use	Energy	Number	Power	Use	Energy	
Lamp Led	8	15 W/lamp	6 h/day	720 Wh/day	8	15 W/lamp	720 h/day	720 Wh/day	
TV/PC/Mobil	2	150 W/app	4 h/day	1200 Wh/day	2	150 W/app	1200 h/day	1200 Wh/day	
Aer conditionat	1	370 W/app	4 h/day	1480 Wh/day	1	370 W/app	1480 h/day	1480 Wh/day	
Frigider	1		24 Wh/day	581 Wh/day	1		24 Wh/day	581 Wh/day	
Masina de spalut	1		1 Wh/day	1200 Wh/day	1		1 Wh/day	1200 Wh/day	
Plita electrica/Prajitor paine/Sistem audio	1	1000 W tot	1 h/day	1000 Wh/day	1	1000 W tot	1000 h/day	1000 Wh/day	
Boiler electric	1	2000 W tot	1 h/day	2000 Wh/day	1	2000 W tot	2000 h/day	2000 Wh/day	
Stand-by consumers			24 h/day	240 Wh/day			24 h/day	240 Wh/day	
<b>Total daily energy</b>				<b>7921 Wh/day</b>				<b>7921 Wh/day</b>	

July and August									
	Number	Power	Use	Energy	Number	Power	Use	Energy	
Lamp Led	8	15 W/lamp	6 h/day	720 Wh/day	8	15 W/lamp	720 h/day	720 Wh/day	
TV/PC/Mobil	2	150 W/app	4 h/day	1200 Wh/day	2	150 W/app	1200 h/day	1200 Wh/day	
Aer conditionat	1	370 W/app	4 h/day	1480 Wh/day	1	370 W/app	1480 h/day	1480 Wh/day	
Frigider	1		24 Wh/day	581 Wh/day	1		24 Wh/day	581 Wh/day	
Masina de spalut	1		1 Wh/day	1200 Wh/day	1		1 Wh/day	1200 Wh/day	
Plita electrica/Prajitor paine/Sistem audio	1	1000 W tot	1 h/day	1000 Wh/day	1	1000 W tot	1000 h/day	1000 Wh/day	
Boiler electric	1	2000 W tot	1 h/day	2000 Wh/day	1	2000 W tot	2000 h/day	2000 Wh/day	
Stand-by consumers			24 h/day	240 Wh/day			24 h/day	240 Wh/day	
<b>Total daily energy</b>				<b>7921 Wh/day</b>				<b>7921 Wh/day</b>	

September and October									
	Number	Power	Use	Energy	Number	Power	Use	Energy	
Lamp Led	8	15 W/lamp	6 h/day	720 Wh/day	8	15 W/lamp	960 h/day	960 Wh/day	
TV/PC/Mobil	2	150 W/app	4 h/day	1200 Wh/day	2	150 W/app	1200 h/day	1200 Wh/day	
Aer conditionat	1	370 W/app	3 h/day	1110 Wh/day	1		1200 h/day	1200 Wh/day	
Frigider	1		24 Wh/day	581 Wh/day	1		24 Wh/day	581 Wh/day	
Masina de spalut	1		1 Wh/day	1200 Wh/day	1		1 Wh/day	1200 Wh/day	
Plita electrica/Prajitor paine/Sistem audio	1	1000 W tot	1 h/day	1000 Wh/day	1	1000 W tot	1000 h/day	1000 Wh/day	
Boiler electric	1	2000 W tot	2 h/day	4000 Wh/day	1	2000 W tot	4000 h/day	4000 Wh/day	
Stand-by consumers			24 h/day	240 Wh/day			24 h/day	240 Wh/day	
<b>Total daily energy</b>				<b>9681 Wh/day</b>				<b>9681 Wh/day</b>	

November and December									
	Number	Power	Use	Energy	Number	Power	Use	Energy	
Lamp Led	8	15 W/lamp	8 h/day	960 Wh/day	8	15 W/lamp	1080 h/day	1080 Wh/day	
TV/PC/Mobil	2	150 W/app	4 h/day	1200 Wh/day	2	150 W/app	600 h/day	600 Wh/day	
Frigider	1		24 Wh/day	581 Wh/day	1		581 Wh/day	581 Wh/day	
Masina de spalut	1		1 Wh/day	1200 Wh/day	1		1200 Wh/day	1200 Wh/day	
Plita electrica/Prajitor paine/Sistem audio	1	1000 W tot	1 h/day	1000 Wh/day	1	1000 W tot	3000 h/day	3000 Wh/day	
Boiler electric	1	2000 W tot	2 h/day	4000 Wh/day	1	2000 W tot	4000 h/day	4000 Wh/day	
Stand-by consumers			24 h/day	240 Wh/day			24 h/day	240 Wh/day	
<b>Total daily energy</b>				<b>9681 Wh/day</b>				<b>9501 Wh/day</b>	

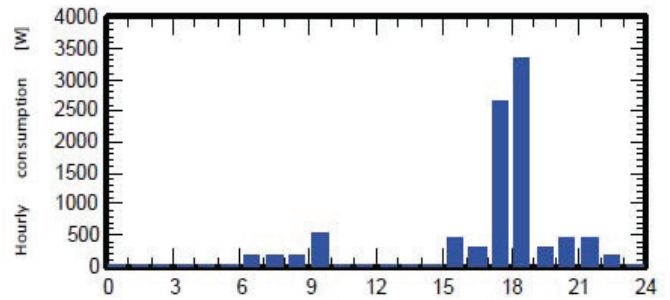

Fig. 18 Hourly consumption distribution per day

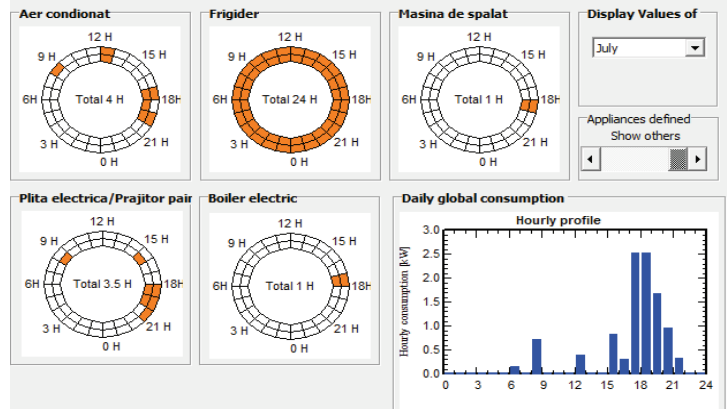

Fig. 19 Hourly consumption distribution in July

Table I shows that we have the lowest consumption in May/November and the highest in July. On average it is a consumption of a 9.5 kWh/day (3467 kWh/year and 288 kWh/month). Following the simulation, the following results were obtained

TABLE II

FIRST SYSTEM RESULTS TABLE

	GlobHor kWh/m <sup>2</sup>	DiffHor kWh/m <sup>2</sup>	T_Amb °C	GlobInc kWh/m <sup>2</sup>	GlobEff kWh/m <sup>2</sup>	EArray kWh	E_User kWh	E_Solar kWh	E_Grid kWh	EfrGrid kWh
January	41.8	22.70	-1.06	72.1	70.2	197.8	295.8	29.3	162.4	266.5
February	64.2	29.70	0.95	101.2	98.7	273.6	267.1	39.6	227.1	227.5
March	103.7	52.60	6.46	130.6	127.0	340.9	284.6	48.3	283.7	236.3
April	147.1	65.40	11.99	164.6	159.8	415.2	268.2	48.9	355.7	219.3
May	186.8	79.70	18.62	187.6	181.9	460.6	245.5	60.7	388.2	184.9
June	201.7	75.10	22.01	192.3	186.3	464.0	312.6	104.7	347.3	207.9
July	213.5	72.90	24.88	209.6	203.3	497.7	338.5	96.1	388.8	242.4
August	176.4	78.60	24.20	189.9	184.5	452.4	323.0	94.1	346.6	228.9
September	135.2	51.30	17.46	170.1	165.5	419.5	301.5	66.4	343.1	235.1
October	88.5	35.80	12.29	131.8	128.6	336.0	269.1	43.6	283.9	225.5
November	49.6	25.10	6.61	85.2	83.0	226.3	260.4	31.0	187.7	229.4
December	34.5	18.50	0.70	64.9	63.1	177.6	294.5	12.0	159.7	282.5
Year	1443.0	607.40	12.16	1700.1	1651.8	4260.6	3461.1	674.7	3474.3	2786.3

Legends: GlobHor Horizontal global irradiation  
 DiffHor Horizontal diffuse irradiation  
 T\_Amb Ambient Temperature  
 GlobInc Global incident in coll. plane  
 GlobEff Effective Global, corr. for IAM and shadings  
 EArray Effective energy at the output of the array  
 E\_User Energy supplied to the user  
 E\_Solar Energy from the sun  
 E\_Grid Energy injected into grid  
 EfrGrid Energy from the grid



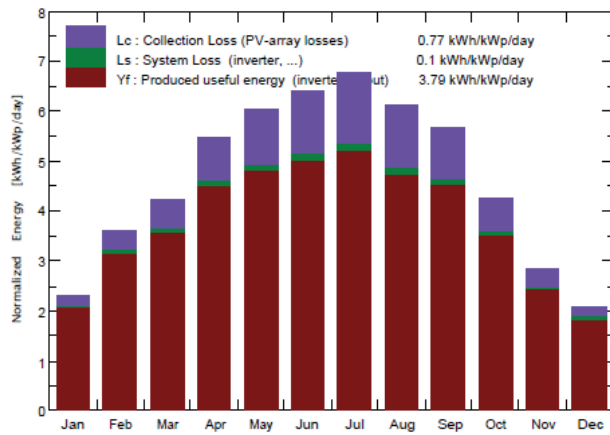

Fig. 20 The final production (with system losses)

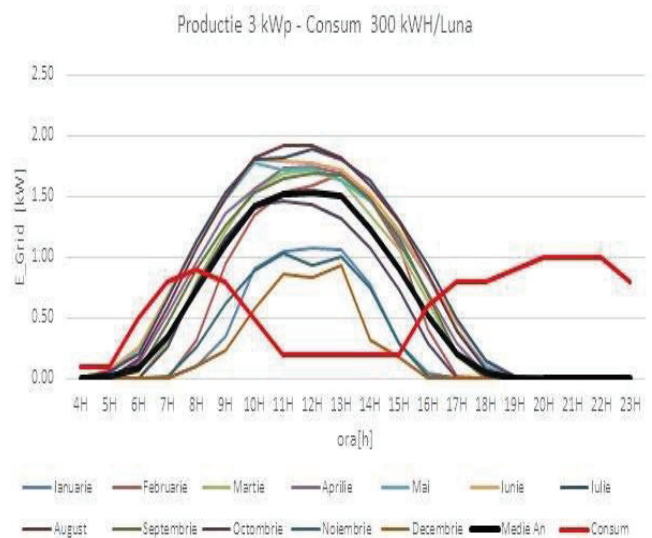

Fig. 22 Load curve of the classic prosumer

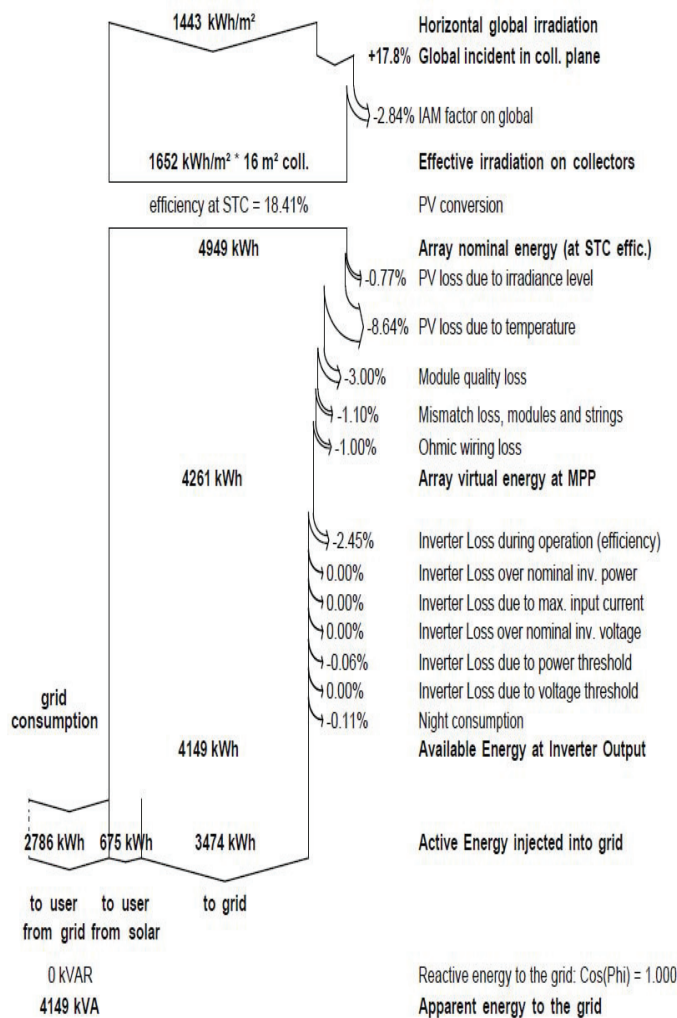

Fig. 21 Diagram of losses for the entire year (from the first/classic system)

Following the simulation of the classic on-grid photovoltaic system of 3 kW, for the entire year, 4949 kWh is produced, of which 800 kWh are lost (see fig. 21) and an energy of 4149 kWh remains "net", of which:

- 675 kWh is used by the user, resulting in a contribution of 16.26% of photovoltaic energy;
- 3474 kWh is sold in the electricity network;
- The remaining 2786 kWh is extracted from the grid;

Considering that the current price at ENEL Dobrogea is 0.7 RON/kWh (taxes included) results an average monthly for the electricity bill invoiced value of ( table 1) :

$$0.7\text{RON/kWh} \times 288.41\text{kWh} = 201.88 \text{ RON} \quad (1)$$

Doing the calculations after the simulation we have the following financial contribution:

- The annual reduction of 675kWh to the energy consumed from the network being produced by the photovoltaic system.

The value of this saving is:

$$675\text{kWh} \times 0.7 \text{ RON} = 540 \text{ RON/year} \quad (2)$$

- To be collected from the electricity supplier for the 3474 kWh. For the electricity delivered in the network, 0.22 lei / kWh is paid (see legislation). The value of this ratio is:

$$0.22\text{lei/kWh} \times 3474\text{kWh} = 764.2 \text{ RON/ year} \quad (3)$$

The total value saved annually will be:

$$540\text{RON} + 764.28\text{RON} = 1304.28 \text{ RON / year} \quad (4)$$

Of the 2786 kWh taken from the network, the following will be paid:

$$0.7\text{RON/kWh} \times 2786\text{kWh} = 1950.2 \text{ RON / year.} \quad (5)$$

From the calculations it results that per year the beneficiary will pay:

$$1950.2\text{RON} - 1304.28\text{RON} = 645.92 \text{ RON} \quad (6)$$

## B. Smart prosumer analysis

In the smart system, the own energy production is maximized by the automatic control of the households applications, putting them into operation when there is energy produce by the photovoltaic system.



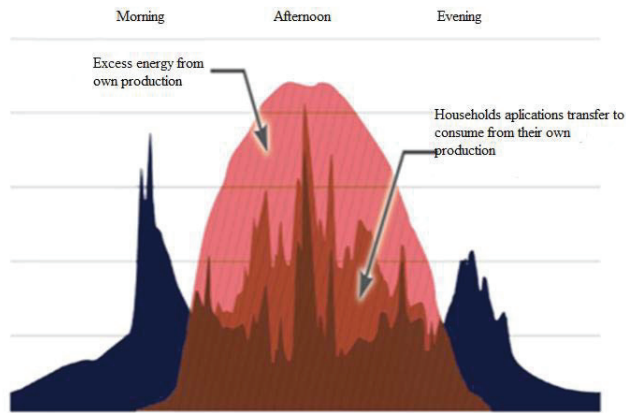

Fig. 23 Energy curve (smart system)

We start from the premise with same consumers with the same power and the same time (see Table I). These are distributed according to the needs of the user and the intelligence of the system, having a different consumption profile (see fig.24), moving automatically the large consumers in the peak of the afternoon (where the most of the energy is produced by the photovoltaic)

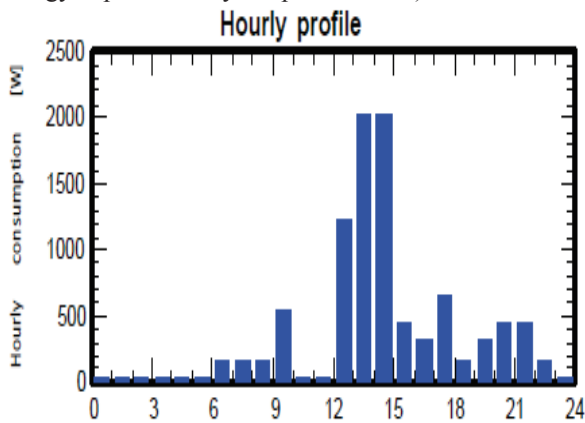

Fig. 24 Hourly consumption distribution per day (the smart system)

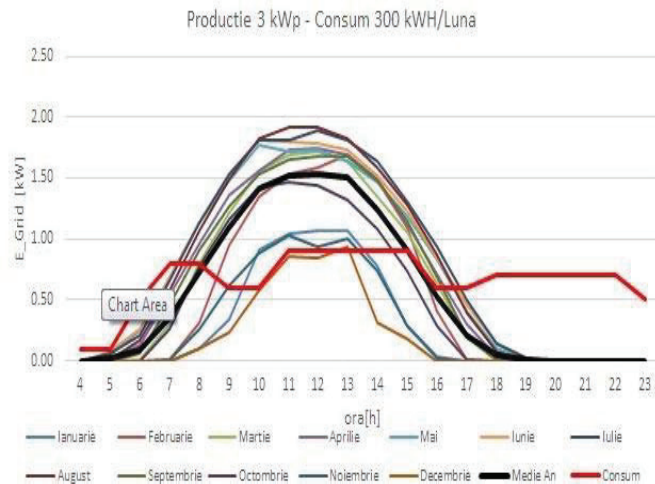

Fig. 25 Load curve of the smart prosumer

Following the simulation, we obtained the following results

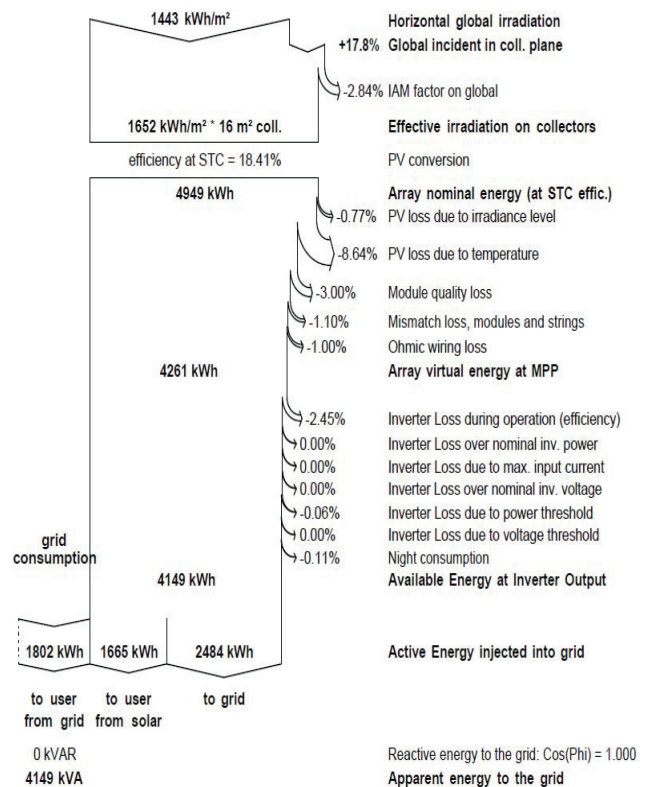

Fig. 26 Diagram of losses for the entire calendar year (from the second/smart system)

Following the simulation of the 3kW on-grid photovoltaic smart system, for the whole year the same energy of 4949kWh is produced, of which 800kWh is lost (fig. 26) and a net energy of 4149kWh remains, of which:

- 1665kWh is used by the user, resulting in a contribution of 40% of photovoltaic energy
- 2484 kWh is sold in the electricity network
- The remaining 1802 kWh is extracted from the electrical network

Considering that the current price at ENEL Dobrogea is 0.7 lei / kWh (taxes included) results an average for the electricity bill monthly invoiced value of:

$$0.7\text{RON/kWh} \times 288.4\text{kWh} = 201.887 \text{ RON} \quad (7)$$

Doing the calculations after the simulation we have the following financial contribution:

- The annual reduction of 1665 kWh to the energy consumed from the network being produced by the photovoltaic system. The value of this saving is:

$$1665\text{kWh} \times 0.7\text{RON/kWh} = 1165.5 \text{ RON/year} \quad (8)$$

- To be collected from the electricity supplier for the 2484 kWh. For the electricity delivered in the network, 0.22 RON / kWh is paid [3]. The value of this ratio is:

$$0.22\text{RON/kWh} \times 2484\text{kWh} = 546.48 \text{ RON/year} \quad (9)$$

The total value saved annually will be:

$$1165.5\text{RON} + 546.48\text{RON} = 1711.98 \text{ RON/year} \quad (10)$$

Of the 1802 kWh taken from the network, the following will be paid:

$$0.7\text{RON/kWh} \times 1802\text{kWh} = 1261.4 \text{ RON/year} \quad (11)$$

From the calculations (10)(11) it results that per / year the beneficiary will receive from the electricity distributor 450.58 RON/year (92.521 Euro/year)

\* 1EURO = 4.9 RON

## V. CONCLUSIONS

The sizing of the photovoltaic system is done taking into account the power peaks during the day, moving consumers, as much as possible, during the 6 hours centered on noon. Given that the price of one kW / installed is on average or higher than 1200 Euro (VAT + installation + transport + maintenance), the cost for 3kW will be 3600 Euro, it results from calculations that the depreciation will be made in 12-13 years if the photovoltaic energy produced per day will be at least 15%, the excess of 85% being injected into the national grid. But through the AFM program, which represents approximately 90% of the investment, for this user, the depreciation of the photovoltaic system is done in less than 2 years in the case of the classic system. In the case of the intelligent system, the amortization without subsidies within AFM will be achieved in approximately 11 years, and with a subsidy of around 1 year. For a given consumption, which in the present example is 3461 kWh per year, no matter how much we increase the photovoltaic power over a certain value (in this case 3kW) the self-consumption does not increase and the value increase comes only from the sale of energy. For the payment versus the collection to be equal to 0 for a 3kW system, the share of energy consumed in photovoltaics should be around 30%, which would not be impossible with a classic system (it depends on several factors)

Locally produced energy ensures an increased degree of energy resilience, because in case of a lack of voltage at the level of the main network, the prosumer can operate insularized (similar to the microgrid). The network can be relieved of current problems of renewable sources if the prosumer controls his production, storage and consumption in such a way that he is always seen only as a consumer. The digitization of electricity networks, together with the increase in the "intelligence" of energy consumption devices - enhanced in particular by the development trend of the "internet of things" will gradually lead to an increase in automated two-way energy exchanges, between distribution networks and active consumption systems. However, there are also some risks related to the still insufficiently known behavior of such systems, so that their efficient integration in the energy markets involves pilot projects and comparative studies, in order to learn good practices.

**Acknowledgement:** This work was financially supported by the Ministry of European Funds of Romania, under the Scientific Programme: Competitiveness Operational Programme, Priority Axis 1, Action 1.2.3 Knowledge Transfer Partnerships, Project: Transfer of knowledge to the private companies in the energy domain based on the

scientific experience of ICPE-CA -TRANSENERG, no. P\_40\_432 / 105567, Contract no. 126/C2/2020

## REFERENCES

- [1] Petru Ruset, Florentin Batrinu, Radu Porumb. "The Challenges of the Electrical Systems of The future", 2020 55th International Universities Power Engineering Conference (UPEC), 2020
- [2] Cristian Lazaroiu, Maria Cristina Roscia. "RESCoin to improve Prosumer Side Management into Smart City", 2018 7th International Conference on Renewable Energy Research and Application (ICRERA), 2018
- [3] S. Gheorghe, N. Golovanov, G.-C. Lazaroiu, R. Porumb, "Smart grid, integration of renewable sources and improvement of power quality", CSCS 2017, 29-31 May 2017, Bucharest, Romania, pp. 641-645, DOI: 10.1109/CSCS.2017.98
- [4] Petronela-Raluca Mincu, Tudor-Alexandru Boboc. "Load Profiles in Smart CITIES", 2017 International Conference on Energy and Environment (CIEM), 2017
- [5] Stavros Lazarou, Christos Christodoulou, Vasiliki Vita. "Global Change Assessment Model (GCMA) consideration of the primary sources energy mix for an energetic scenario that could meet Paris Agreement", 2019 54th International Universities Power Engineering Conference (UPEC), 2019
- [6] Ioan Sarbu. "Advances in Building Services Engineering", Springer Science and Business Media LLC, 2021
- [7] Lucian Pislaru-Dănescu, Elena Chitanu, Lucia-Andreea El-Leathy, Virgil Marinescu, Dorian Marin, Beatrice-Gabriela Sbârcea. "Synthesis and Characterization of Antireflective ZnO Nanoparticles Coatings Used for Energy Improving Efficiency of Silicone Solar Cells", Electronic Materials Letters, 2018
- [8] L. N Canha, O. M. Adeyanju, R. C. Ney, G. Arend, D. N. Zancan. "The Roles of Customers, Utilities and Companies in Accelerating Smart Grid Implementation", 2019 IEEE PES Innovative Smart Grid Technologies Conference - Latin America (ISGT Latin America), 2019
- [9] www.upb.ro
- [10] Sorin-Dan Grigorescu, George-Calin Seritan, Bogdan-Adrian Enache, Felix-Constantin Adochiei et al. "Robotic Platform for Recovering Injured People in Smart Home", 2020 International Conference on e-Health and Bioengineering (EHB), 2020
- [11] eur-lex.europa.eu
- [12] Stefan Gheorghe, Nicolae Golovanov, George Cristian Lazaroiu, Carmen Stanescu, Gabriel Gheorghe. "The connection of renewable sources to the grid. Influences and power quality issues", 2017 10th International Symposium on Advanced Topics in Electrical Engineering (ATEE), 2017
- [13] cordis.europa.eu
- [14] www.mdpi.com
- [15] doctorat.acs.pub.ro
- [16] ro.wikipedia.org
- [17] www.crossref.org
- [18] ANRE.ro/legislatie/prosumatori (site consulted on 23th of February 2021, 19:19)
- [19] AFM.ro (site consulted on 15th of February 2021, 18:10)
- [20] Directiva 2009/28 / CE privind promovarea utilizării energiei din surse regenerabile
- [21] PVSYS.COM (site consulted on 16th of February 2021, 19:56)
- [22] Raport national ANRE 2018 emis la 31 iulie 2019
- [23] Pasan Highlight (site consulted on 17th of February 2021, 16:38)
- [24] PVWATTS.nrel.gov (site consulted on 17th of February 2021, 17:14)
- [25] energie.gov.ro/electricup (site consulted on 17th of February 2021, 19:03)
- [26] https://ec.europa.eu/jrc/en/pvgis
- [27] eurostat.com
- [28] https://www.kiwisolar.co.nz/solar-electricity-2/attachment/solutions/
- [29] bloomberg new energy financ & pv.energytrend.com
- [30] PVTRIN (installer certification)
- [31] G.Chicco, O.-M.Ionel, R.Porumb, Formation of load pattern clusters exploiting ant colony clustering principles, 2013 IEEE, Editor: IEEE, Organizer: University of Zagreb, 1-4 July 2013, Zagreb, Croatia, Page(s): 1460 - 1467, DOI: 0.1109/EUROCON.2013.6625170
- [32] R.Porumb, N.Golovanov, C.Toader, P.Postolache, "Electrical load pattern for LV consumers. A Romanian case", UPEC 2012, Uxbridge, UK, DOI:10.1109/UPEC.2012.6398427