



## Programming Resistive States of Memristive Devices via Current Control

---

Evgeny Bukvarev, Ksenya Fomina, Semen Shabalin and  
Sergey Shchanikov

EasyChair preprints are intended for rapid  
dissemination of research results and are  
integrated with the rest of EasyChair.

August 3, 2022

# Programming Resistive States of Memristive Devices via Current Control

Evgeny Bukvarev

*Educational and Scientific Institute of  
Radio Electronics and Information  
Technologies*

*Nizhny Novgorod State Technical  
University named after R.E. Alekseev*  
Nizhny Novgorod, Russia  
bukvarev@nntu.ru

Ksenya Fomina

*Educational and Scientific Institute of  
Radio Electronics and Information  
Technologies*

*Nizhny Novgorod State Technical  
University named after R.E. Alekseev*  
Nizhny Novgorod, Russia  
ksf96@mail.ru

Semen Shabalin

*Educational and Scientific Institute of  
Radio Electronics and Information  
Technologies*

*Nizhny Novgorod State Technical  
University named after R.E. Alekseev*  
Nizhny Novgorod, Russia  
shabalin.semyon@yandex.ru

Sergey Shchanikov

*Department of Information Technology  
Murom Institute Vladimir State  
University*

Murom, Russia

*Research Institute of Physics and  
Technology*

*Lobachevsky University*  
Nizhny Novgorod, Russia  
seach@inbox.ru

**Abstract**—Arrays of memristors can be used in promising neural computing systems as a programmable resistance (analog multiplication ratio) when performing operations of analog scalar multiplication of vectors, discrete in time. To form the required resistance, the memristor must be subjected to a "programming" procedure. The procedure can be carried out in two different ways, related to the different direction of movement according to the volt-ampere characteristic of the memristor. The paper deals with the proposed memristor elements programming device based on a digital-analog converter and a variable resistor. The paper says about the advantages and disadvantages of various existing and possible programming methods. The developed device is universal and does not require additional analysis of the output voltage.

**Keywords**—memristor, programmable resistance, analog neural calculations, programming scheme, artificial intelligence

## I. INTRODUCTION

A memristor is a passive element in microelectronics that can change its resistance under the action of an electric field and a charge flowing through it, and also maintain resistance for a long time. The memristor has a non-linear current-voltage characteristic (Fig. 1). An array of memristor elements can be used in promising systems of neurocomputing [1–4] as a programmable resistance (analog multiplication factor) [5, 6], when performing operations of analog multiplication of vectors [7]. An important scientific and technical task is the development of methods and hardware that directly work with arrays of memristor elements. At the same time, the methods and hardware should ensure measuring (reading mode) and controllable change (programming mode) of the resistance of these elements. The typical programming schemes are considered in this paper, and also a new scheme for a universal programming device are proposed. This scheme was developed for memristor elements of the "metal-dielectric-metal" type, where yttrium-stabilized zirconium dioxide is used as the main dielectric [8, 9]. However, this scheme can

be adapted by selecting the values of electronic components to operate with memristors that are manufactured using different technologies. The current-voltage characteristic (I-V) of the used memristors with the Au/Ta/ZrO<sub>2</sub>/Pt/Ti structure is shown in Fig. 1. This I-V characteristic was built when a sawtooth reamer was applied to the memristor in terms of voltage in the range from -2 to 2 V. The developed memristors are very low-voltage, which is important for energy-efficient neurocomputing. For their programming in all modes, it is enough that the current and voltage drivers operate in the specified ranges of values.

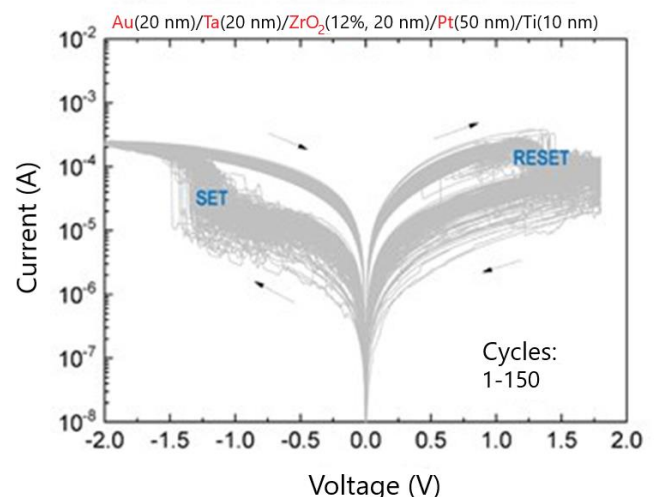

Fig. 1. I-V-characteristic of experimental sample of a cross-bar memristor with indicating transitions

In order to exclude unwanted changes in the resistance of these memristors in the reading mode [10], it is advisable to select the voltage of the signal sources in the range from -0.25 to 0.25 V. This range corresponds to the I-V characteristic section, where there is no hysteresis (see Fig. 1). When the

voltage on the memristor changes, the current passing through it changes, as indicated by the arrows in Fig. 1. There are two boundary states of the memristor [11, 12]:

- LRS (Low Resistance State);
- HRS (High Resistance State).

As it moves along the I-V characteristic, the memristor element can change its state from HRS to LRS. This transition is called "SET". The transition in the opposite direction, from LRS to HRS is commonly called "RESET" [11, 12].

The memristor programming procedure in the "SET" transition is commonly called [11] "Decremental programming", and in the "RESET" transition - "Incremental programming".

## II. TRANSITION TO HIGH RESISTANCE STATE

A typical programming scheme in "RESET" is presented in [11]. Similar programming schemes are also presented in [12, 13].

The principle of operation of this scheme is as follows: the memristor is transferred to the LRS state, then pulses with a given duration (in our case  $40 \mu\text{s}$ ) and period ( $100 \mu\text{s}$ ) are fed to its input. With each new pulse, the conductivity of the memristor gradually decreases, and the voltage "op\_out" at the output of the converter increases due to a decrease in the resistance ratio  $R_2/R(m(t))$ . When the conductivity decreases to a predetermined value, the process is interrupted, and the memristor is considered programmed.

The results of scheme modeling are shown in Fig. 2. This method is convenient in that it can be implemented within the framework of a combined cross-bar control architecture. Thus, the operating voltage source can be combined with the programming voltage source, the receiver can be combined with the ADC, and the programming process itself can be parallelized by lines [13].

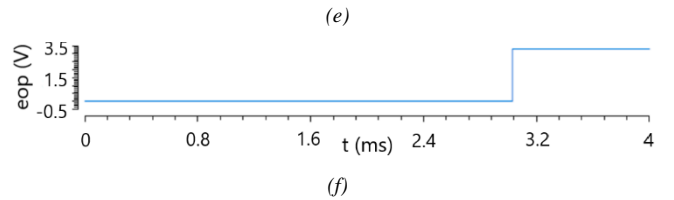
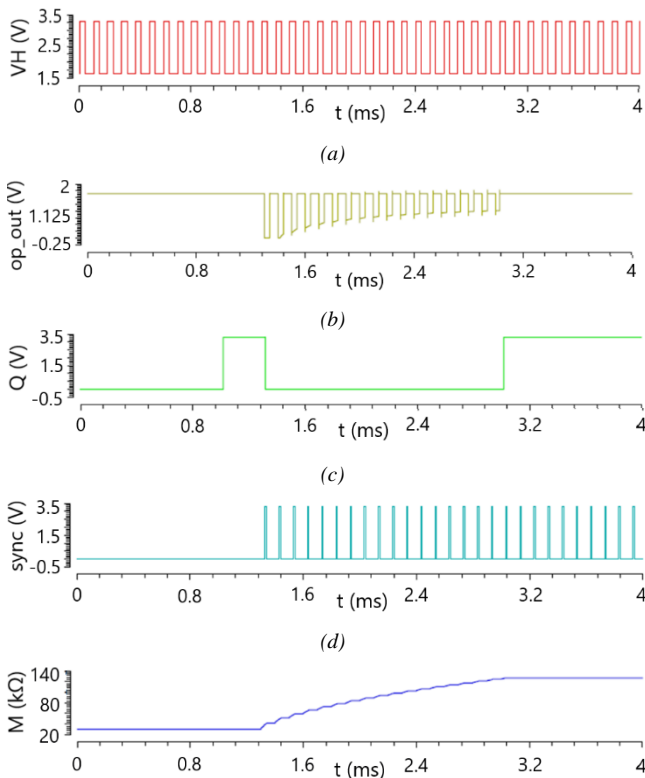

Fig. 2. Results of modeling the programming scheme of a memristor in a high-impedance state:

*a* – input signal; *b* – output voltage of the operational amplifier; *c* – comparator output signal; *d* – strobe pulses; *e* – a plot of the programmed memristance; *f* – signal of the end of programming

However, the nature of the change in the resistance of the memristor during programming is rather non-linear (see Fig. 2).

## III. TRANSITION TO LOW IMPEDANCE STATE

A typical programming scheme in "SET" is presented in [11]. The scheme differs from the previously considered one in that the programmable memristor is placement in the feedback circuit of the current-voltage converter.

The results of simulation of this scheme are shown in Fig. 3. Unlike the previous scheme, the programming pulses are inverted. The initial state of the memristor is HRS. Then, as the pulse number increases, its resistance begins to decrease. The blue color (curve  $M(k\Omega)$ ) shows the change in the resistance of the memristor. The programming process ends as soon as the voltage at the output of the current-to-voltage converter is less than the threshold value  $V_{th}$ .

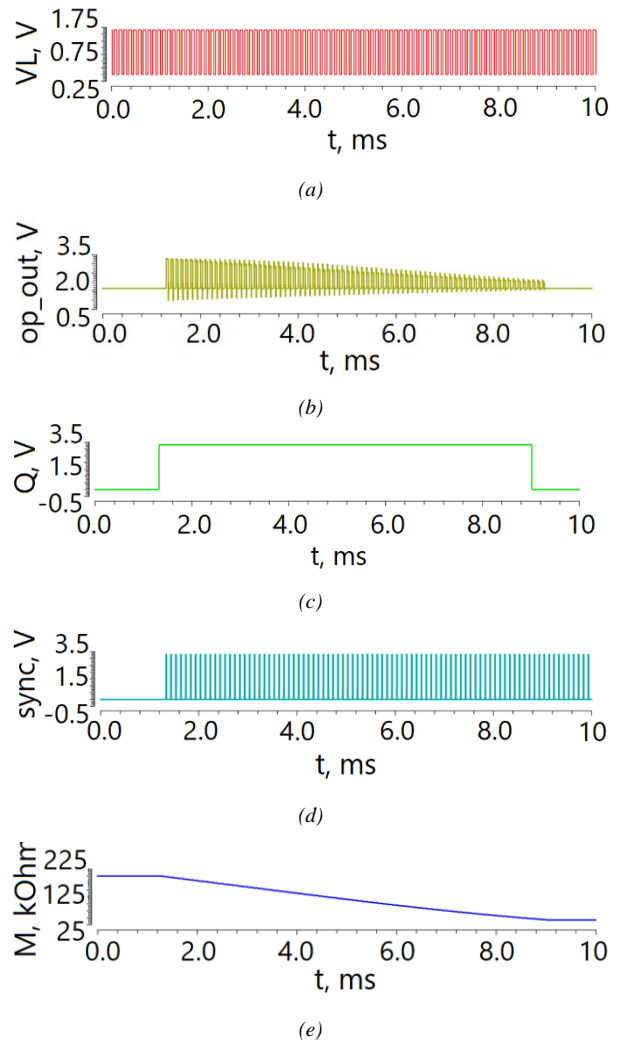

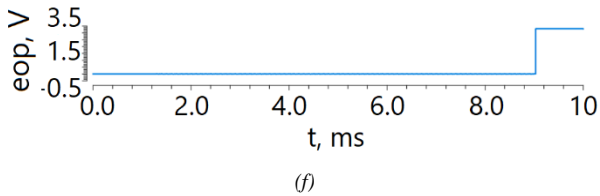

Fig. 3. Results of modeling the programming scheme of a memristor in a low-impedance state:

*a* – input signal; *b* – output voltage of the operational amplifier; *c* – comparator output signal; *d* – strobe pulses; *e* – a plot of the programmed memristance; *f* – signal of the end of programming

Programming in the "SET" transition has the advantage from point of view better linearity. But with such an implementation, it becomes necessary to switch the memristor [14], which excludes the possibility of using the programming mode combined with the main operating mode of the device.

To prevent the failure of the memristor, it is necessary to provide a current limit [15]. Then the programming method in "SET" is more convenient for the following reasons:

- the memristor current is strictly limited by the resistor in LRS scheme while, as in the circuit in HRS scheme, with an unsuccessful choice of operational amplifier, the current may be limited only by the internal resistance of the memristor;
- the programming process starts with small currents, which is safer.

#### IV. PROGRAMMING SCHEME USING A VARIABLE RESISTOR

A universal programming device based on a scheme with a memristor placed in the feedback circuit of the operational amplifier is proposed. Fig. 4 shows a structural scheme of such a device. It contains a bipolar generator of the programming voltage  $V_p$  at the input, two identical channels of the op amp DA1 and DA2, one of which contains a programmable memristor MR, and the other has an exemplary variable resistor RP, a comparator DA3 at the output.

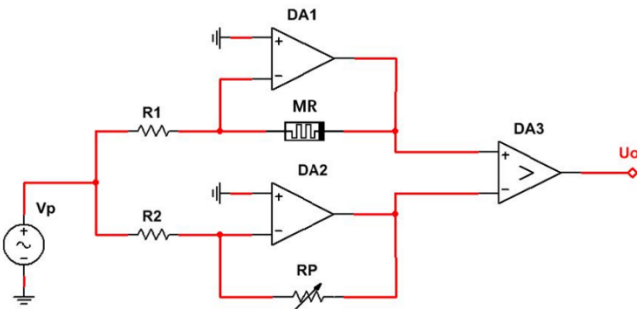

Fig. 4. Programming scheme using a variable resistor

The programming process begins by resetting the memristor to the HRS. After that, the adjustment to the desired resistance of the variable resistor is carried out. This resistance will have a memristor at the end of the programming process. Then, a sequence of pulses [11] or a linearly increasing voltage is formed at the source output  $V_p$ . At the same time, in the DA1 circuit, a gradually increasing current will flow through the memristor MR, and the conductivity of the memristor will increase. At the moment when the internal resistance MR is equal to the resistance RP, the voltage at the output DA1 will exceed the voltage at the output DA2. Then the comparator DA3 will switch, and the voltage  $U_o$  will

change polarity. This will be the criterion for completing the programming process.

The use of a bipolar voltage source  $V_p$  and a bipolar operational amplifier in this scheme allows programming of any type, both "Decremental" and "Incremental", as well as transferring the memristor to any state without re-switching it.

Fig. 5 shows the operation of the programmer when the resistance of the variable resistor varies in the range from 10 to 90 kOhm in steps of 20 kOhm. The moments of operation of the comparator turn out to be exactly at the moment of equality of the resistances of the memristor and the variable resistor in the entire range of changing values.

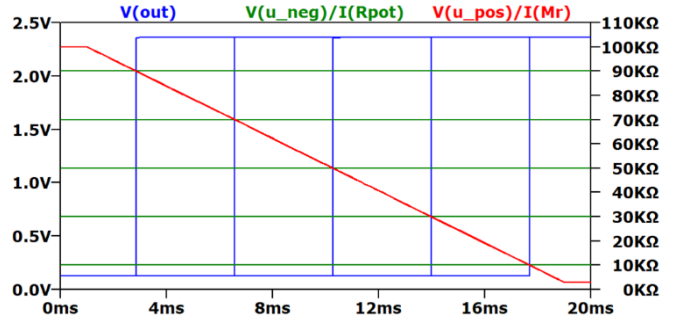

Fig. 5. Simulation results with variable resistor resistance variation from 10 to 90 kOhm

The simulation results confirm the operability of the structural and scheme solutions embedded in the programmer node.

#### V. CONCLUSIONS

According to the results of the research, it seems a rational choice to use a programming circuit using a variable resistor as part of a cross-bar control device. An ADC also can be added into the scheme, the input of which will be connected to the output DA1. Thus, it becomes possible to choose a device for measuring the resistance of the memristor both during programming and for the purpose of monitoring the resistance of the memristor at the end of the procedure.

The use of a bipolar voltage source  $V_p$  and a bipolar operational amplifier in this scheme allows programming of any type (both "Decremental" and "Incremental"). The transfer of the memristor to any state is then possible without its re-switching.

#### ACKNOWLEDGMENT

The project was supported by a Grant from the Ministry of Science and Higher Education of the Russian Federation (project No. 13.2251.21.0098, Agreement No. 075-15- 2021-1017).

#### REFERENCES

- [1] G. Sharma and L. Bhargava, CMOS-Memristor Inverter Circuit Design and Analysis Using Cadence Virtuoso. 2016 International Conference on Recent Advances and Innovations in Engineering (ICRAIE), Jaipur, India, 23-25 Dec. 2016, pp. 1–5.
- [2] N. C. Dao and D. Koch, Memristor-based Reconfigurable Circuits: Challenges in Implementation. 2020 International Conference on Electronics, Information, and Communication (ICEIC), Barcelona, Spain, 19-22 Jan. 2020, pp. 1–6.
- [3] P. Yao et al., Fully hardware-implemented memristor convolutional neural network. Nature, vol. 577, no. 7792, pp. 641–646.
- [4] W. Zhang et al., Neuro-inspired computing chips. Nature Electronics, vol. 3, pp. 371–382.

- [5] M. A. Zidan, J. P. Strachan and W. D. Lu, The future of electronics based on memristive systems. *Nature Electronics*, vol. 1, pp. 22–29.
- [6] A. Mikhaylov et al., Neurohybrid Memristive CMOS-Integrated Systems for Biosensors and Neuroprosthetics. *Frontiers in Neuroscience*, vol. 14, pp. 1–14, 2020.
- [7] A. Amirsoleimani et al., In-memory vector-matrix multiplication in monolithic complementary metal–oxide–semiconductor-memristor integrated circuits: Design choices, challenges, and perspectives: [Review]. *Advanced Intelligent Systems*, Wiley, 2020, vol. 2, no. 11, pp. 2000115.
- [8] A. V. Emelyanov et al., Yttria-stabilized zirconia cross-point memristive devices for neuromorphic applications. *Microelectronic Engineering*, vol. 215, pp. 110988.
- [9] S. Shchanikov et al., Design and Hardware Implementation of Memristor-Based Multilayer Perceptron Network for a Bidirectional Adaptive Neural Interface. *2021 Third International Conference Neurotechnologies and Neurointerfaces (CNN)*, Kaliningrad, Russian Federation, 13-15 Sept. 2021, pp. 100-103.
- [10] S. M. A. Mokhtar, W. F. H. Abdullah, K. A. Kadiran, R. Rifin and M. Omar, Write and Read Circuit for Memristor Analog Resistance Switching Constantine. *2017 IEEE 8th Control and System Graduate Research Colloquium (ICSGRC)*, Shah Alam, Malaysia, 4-5 Aug. 2017, pp. 13–16.
- [11] O. A. Olumodeji and M. Gottardi, A pulse-based memristor programming circuit. *IEEE International Symposium on Circuits and Systems (ISCAS)*, Baltimore, Maryland, USA, 28-31 May 2017, pp. 1–4.
- [12] T.-W. Lee and J. H. Nickel, Memristor Resistance Modulation for Analog Applications. *IEEE Electron Device Letters*, vol. 33, no. 10, 2012, pp. 1456–1458.
- [13] L. Zhang et al., An Efficient Programming Framework for Memristor-based Neuromorphic Computing Grace. *Design, Automation & Test in Europe Conference & Exhibition (DATE)*, Grenoble, France, 1-5 Feb. 2021, pp. 1068–1073.
- [14] M. Zhao, B. Gao, J. Tang, H. Qian and H. Wu, Reliability of analog resistive switching memory for neuromorphic computing. *Applied Physics Reviews*, vol. 7 no. 1, pp. 011301.
- [15] J. Gomez, I. Vourkas and A. Abusleme, Exploring Memristor Multi-Level Tuning Dependencies on the Applied Pulse Properties via a Low Cost Instrumentation Setup. *IEEE Access*, vol. 7, 2019, pp. 59413–59421.