



Trapping Investigation of the GaN HEMT Devices Using the Low Frequency Noise Characterization

Mohamed Bouslama, Jean-Christophe Nallatamby and
Michel Prigent

EasyChair preprints are intended for rapid
dissemination of research results and are
integrated with the rest of EasyChair.

April 16, 2019

Trapping Investigation of the GaN HEMT Devices Using the Low Frequency Noise Characterization

Mohamed Bouslama
Xlim Laboratory
University of Limoges
France, Brive-la-Gaillarde
mohamed.bouslama@unilim.fr

Jean-Christophe Nallatamby
Xlim Laboratory
University of Limoges
France, Brive-la-Gaillarde
jean-christophe.nallatamby@unilim.fr

Michel Prigent
Xlim Laboratory
University of Limoges
France, Brive-la-Gaillarde
michel.prigent@unilim.fr

Abstract—This paper, proposes the characterization of the signature of traps existing in the new AlGaIn/GaN HEMT of 0.15 μm ultra-short gate length and 8x50 μm gate width through the output and the input Low Frequency (LF) noise measurement technique. These measurements were performed for varying chuck temperatures (T_{chuck}) ranging between 25 °C and 125 °C and for the same biasing condition by measuring the output or input noise spectral density. The output drain noise spectral density characteristics demonstrate the existence of an acceptor-like traps. The peak value of those traps shifts towards higher frequencies as the temperature increases. The activation energy E_a around 0.51 eV and the cross section σ_n around $5 \times 10^{-15} \text{ cm}^2$ were extracted using Arrhenius equation. Furthermore, the input gate noise spectral density characteristics demonstrate the presence of another type of traps. The peak of this traps does not show the frequency shift as the temperature increases. The leakage current measured before and after LF measurements for $V_{GS} = -6 \text{ V}$, -7 V and for V_{DS} varying from 0 V to 10 V remains lower than 40 $\mu\text{A/mm}$.

Keywords—Arrhenius plot, LF noise, leakage current, traps.

I. INTRODUCTION

The AlGaIn/GaN high-electron-mobility transistor (HEMT) is a focus of interest in efforts to fabricate high power and high-frequency microwave circuits due to the remarkable properties of the GaN material. This is possible thanks to the high electron mobility, the high breakdown voltage and the high thermal conductivity. However, trapping effects remain the biggest problem for GaN community because they significantly limit the dynamic performances of the device and also detracts the device reliability due to the presence of deep level states into the heterostructure, called traps. Several measurement characterization techniques can help researchers to identify and localize these defects. The so-called “traps” can be located in different region and/or interfaces. The origin of these noise sources are correlated with the physical phenomenon occurring in the device. For GaN HEMTs, $1/f$ noise and Generation-Recombination (G-R) noise are considered to be the most important noise sources [1]. The $1/f$ noise could be originated from material due to microscopic degrees of freedom interacting with quantum variables of nano-devices [2]. The G-R noise originates from traps that randomly capture and emit charge carriers, thereby causing fluctuations in the total number of charge carriers available for current transport in the channel [3].

Therefore, to determine the signature of these traps (activation energy (E_a), cross section (σ_n)) in the devices, we propose in

this study a Low Frequency (LF) Noise characterization based on the measurement of the output drain noise and the input gate noise spectral densities using the FFT HP89410A vector signal analyzer [4].

The noise measurement has been performed at different chuck temperatures (T_{chuck}) ranging between 25°C and 125°C and this allows to extract the activation energy (E_a) and capture cross section (σ_n) of the traps located in the device. The paper is organized as follows. Section II describes very briefly the structure of the transistor. Section III describes the setup noise characterization for HEMT device under test (DUT). In Section IV, we present the measured LF drain noise characteristics (output noise power spectral density) and the LF gate noise characteristics (input noise power spectral density) of AlGaIn/GaN HEMT of 0.15 μm ultra-short gate length and 8x50 μm gate width and we discuss the extracted trap parameters. We also verify the leakage current in the end of these measurements to ensure their reliability. Finally, Section VI concludes the paper.

II. DEVICE DESCRIPTION

The structure of the transistor used in this work is based on AlGaIn/GaN HEMTs grown on SiC substrate with a gate length of 0.15 μm and a slanted T-shape profile. A source terminated field-plate is processed to improve the breakdown voltage and the transistor RF gain by a reduction of feed-back capacitance. Experimental details on the thickness of each layers of the device cannot be given due to confidential reasons. This technology offers to frequency bands up to 35GHz covering the need for 5G in particular.

III. CHARACTERIZATION SETUP

A. Noise Work bench

The LF noise of the semiconductor devices can be carried out as equivalent input voltage and current noise sources or in terms of input gate short-circuit current and output drain short-circuit current noise sources as shown in Fig.1. The transistor is modeled as a noiseless transistor with noise current sources at both the ports and their corresponding input

and output noise spectral densities are denoted as S_{lin} and S_{Iout} , respectively.

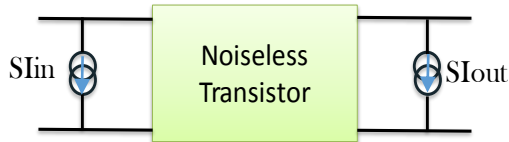

Fig. 1. Noise model of Transistor

In order to measure the noise current sources, different setups have been proposed in the literature [5].

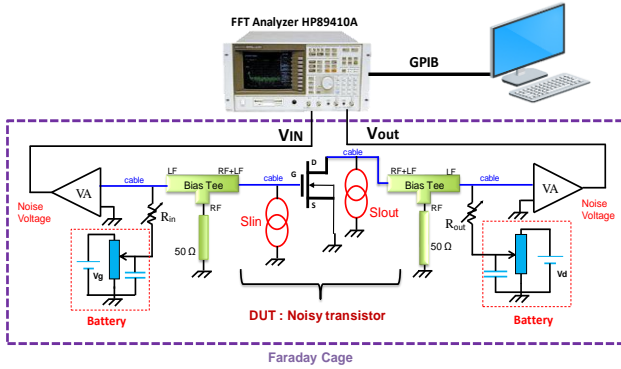

Fig. 2. The complete setup for noise characterization

The Low Frequency noise bench measurement [1], [4] used in this work is shown in Fig. 2. The noise voltages generated by the voltage amplifiers are measured using the HP89410A vector signal analyzer. The FFT vector signal analyzer allows the measure of the signal power either in frequency or the time domain. The noise floor of the measurement test-bench is 3×10^{-27} A²/Hz at 1 KHz and 7×10^{-27} A²/Hz at 100 KHz, respectively. On-wafer LF noise measurements have been performed by including the thermal chuck in the measurement bench and the associated thermal calibration has been performed. The device is biased under deep class-AB operation mode ($V_{DS} = 10$ V and $I_{DS} = 50$ mA/mm). The bias tees are connected in order to avoid the unnecessary oscillations in the RF band. By characterizing the bias tees connected at the input and output terminals of the transistor, the measured power spectral densities S_{Vin} and S_{Vout} are related to the short circuit noise power spectral densities S_{lin} and S_{Iout} of the transistor. In order to avoid the influence of one noise on another, a large value of capacitance (30-mF) is connected at the In or Out node, while measuring the noise at the other terminal. Further details about the noise measurement can be found in [1].

IV. RESULTS AND DISCUSSIONS

A. Output Power Spectral Density

The output noise voltage spectral density S_{Iout} was measured using the noise test-bench shown in Fig. 2 and the corresponding noise current spectral density obtained is shown in Fig. 3. This device is biased under deep class AB operating conditions: $V_{DS} = 10$ V and $I_{DS} = 20$ mA.

It can be noticed that the $1/f$ noise dominates at low frequencies whereas the GR noise dominates at higher frequencies.

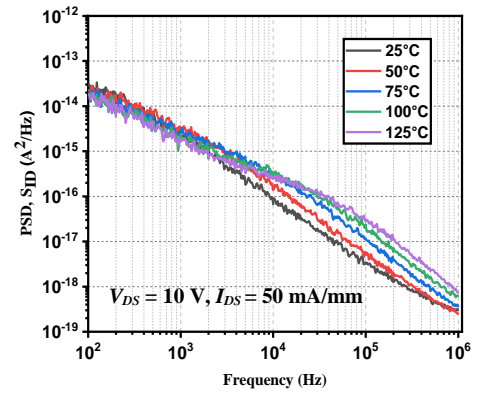

Fig. 3. Output noise power spectral density vs. frequency for the AlGaIn/GaN device measured for various T_{chuck} ranging between 25 °C and 125 °C and under the biasing conditions of $V_{DS} = 10$ V and $I_{DS} = 50$ mA/mm.

B. Trapping Effects

To distinguish GR noise from other measured noise sources, the measured output drain noise spectral density is multiplied by frequency and the corresponding obtained plot for different temperature is shown in Fig. 4.

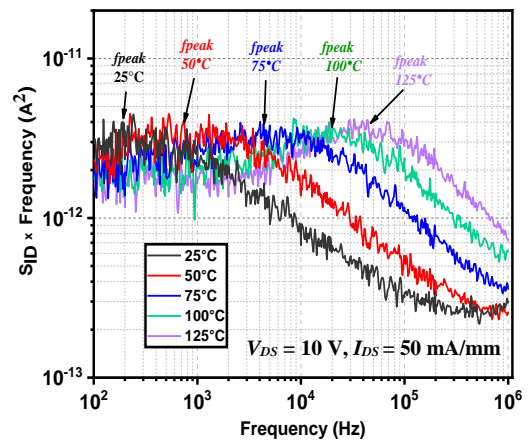

Fig. 4. Output noise power spectral density multiplied by frequency for the AlGaIn/GaN device measured for various T_{chuck} ranging between 25 °C and 125 °C and under the biasing conditions of $V_{DS} = 10$ V and $I_{DS} = 50$ mA/mm.

The peaks observed correspond to the existence of traps in the device structure. The traps cut-off frequencies have been extracted at various temperatures and then, by using the Arrhenius equation [6], the trap activation energy (E_a) and capture cross sections (σ_n) have been determined. A correct extrapolation of the time constant of the de-trapping processes needs to evaluate the self-heating effects of the device. Therefore, the method proposed in [7] is used to extract the thermal resistance R_{TH} of the devices using on-wafer pulsed I(V) measurements. The thermal resistance of the transistor ($R_{TH} = 13$ °C mm/W) has been taken into account while extracting the trapping physical parameters. The corresponding extracted Arrhenius plot is shown in Fig. 5. The apparent activation energy determined is 0.51 eV and the

corresponding capture cross section determined is $5 \times 10^{-15} \text{ cm}^2$.

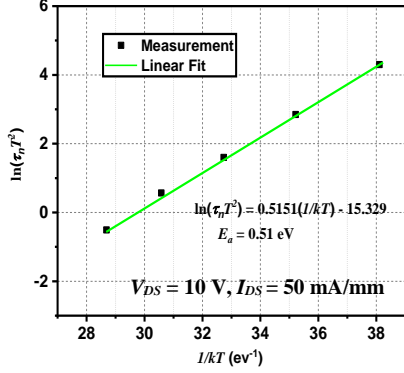

Fig. 5. Extracted Arrhenius plot using LF noise measurement under the biasing conditions of $V_{DS} = 10 \text{ V}$ and $I_{DS} = 50 \text{ mA/mm}$.

To achieve complementary information on the trapping phenomena, measurements are carried out for $I_{DS} = 60 \text{ mA}$ while maintaining the drain voltage $V_{DS} = 10 \text{ V}$. The corresponding output noise current spectral density is shown in Fig. 6. In the same manner as previously described, the corresponding activation (E_a) and cross section (σ_n) obtained using the Arrhenius plot are 0.53 eV and $1.5 \times 10^{-14} \text{ cm}^2$.

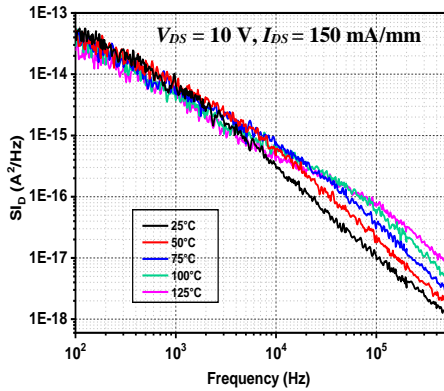

Fig. 6. Output noise power spectral density vs. frequency for the AlGaIn/GaN device measured for various Tchuck ranging between 25°C and 125°C and under the biasing conditions of $V_{DS} = 10 \text{ V}$ and $I_{DS} = 150 \text{ mA/mm}$.

Fig.7 investigates the effect of the measured output noise spectral density multiplied by frequency for the drain current $I_{DS} = 60 \text{ mA}$ for the temperature ranges between 25°C and 125°C . It can be noticed that the cut-off frequency of the detrapping processes depend on the choice of the bias conditions. In our study, the time constant decreases with increasing the drain current. Nevertheless, the values of the activation energy and cross section are very close to the ones obtained for $V_{DS} = 10 \text{ V}$ and $I_{DS} = 20 \text{ mA}$.

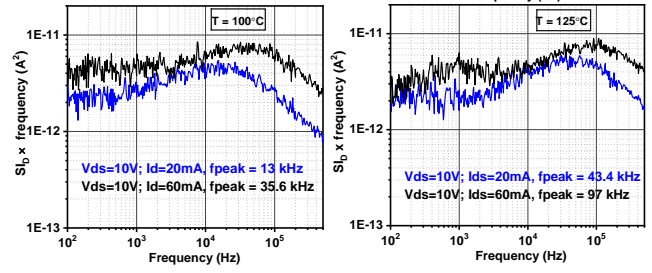
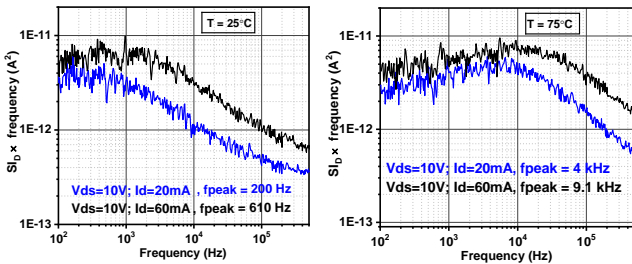

Fig. 7. Output noise power spectral density multiply by frequency under biasing conditions of ($V_{DS}=10 \text{ V}$; $I_{DS}=50 \text{ mA/mm}$) and ($V_{DS}=10 \text{ V}$; $I_{DS}=150 \text{ mA/mm}$) for the AlGaIn/GaN device measured for various Tchuck ranging between 25°C and 125°C .

Fig. 8 exhibits the summary of the deep levels investigated by several research groups for the case of iron doped GaN buffer HEMT devices. On the same plot, we report the curves corresponding to activation energies extracted using low frequency noise measurements. The physical origin of these deep levels could be related to the Fe-doped GaN buffer. Moreover, the extracted activation energies of these deep levels are in good agreement with the already reported value of Fe-doped GaN HEMT devices [4], [8], [9], [10].

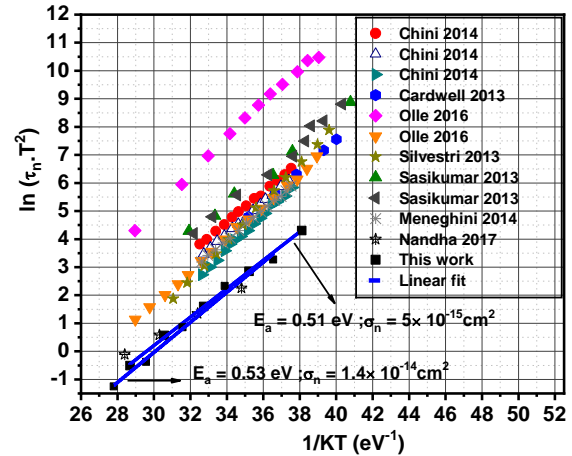

Fig. 8. Summary of the trap states previously reported literature data with two deep levels identified with apparent activation energies of 0.51 eV and 0.53 eV extracted using LF drain noise measurements.

C. Input Power Spectral Density

The input noise voltage spectral density S_{in} was measured using the same biasing condition. The corresponding noise current spectral density obtained is shown in Fig. 9.

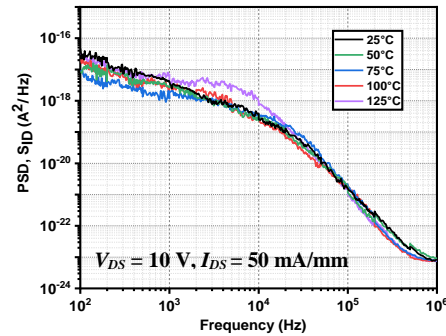

Fig. 9. Input noise power spectral density vs. frequency for the AlGaIn/GaN device measured for various Tchuck ranging between 25°C and 125°C and under the biasing conditions of $V_{DS} = 10 \text{ V}$ and $I_{DS} = 50 \text{ mA/mm}$.

To distinguish GR noise from other measured noise sources, the measured input noise spectral density is multiplied by frequency and the corresponding obtained plot for different temperature is shown in Fig. 10. These data show an absence of temperature dependence. So, the extraction of the signature of traps cannot be highlighted. In order to understand, to localize and identify these traps, two-dimensional (2D) TCAD physics-based device simulations must be performed.

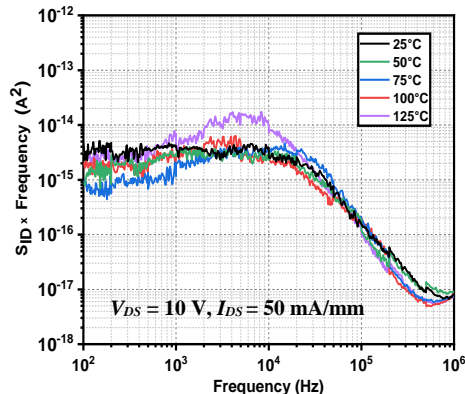

Fig. 10. Input noise power spectral density multiplied by frequency for the AlGaIn/GaN device measured for various T_{chuck} ranging between 25 °C and 125 °C and under the biasing conditions of $V_{DS} = 10$ V and $I_{DS} = 50$ mA/mm.

V. LEAKAGE CURRENT VERIFICATION

To ensure the validity of our measurements, we present in Fig.11 the drain current before and after LF noise measurements which is in a range of μ A/mm. So, for a $V_{GS} = -7$ V and -6 V, we measured the dc drain current (I_{DS}) using the Keysight B1500A analyzer. We can notice that no leakage current was detected (less than 40 μ A/mm), in addition, the current decrease after LF noise measurements.

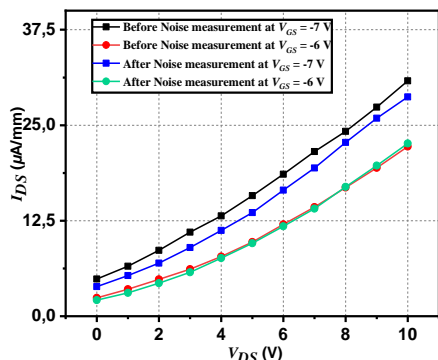

Fig. 11. Measurement of the drain current vs drain voltage for the AlGaIn/GaN transistor at $V_{GS} = -6$ V and -7 V before and after LF noise measurements.

VI. CONCLUSION

In this work, we have investigated the LF drain and gate noise characteristics of the new AlGaIn/GaN HEMTs Transistor of 0.15 μ m ultra-short gate length. The measured drain noise characteristics confirm the existence of traps in the device. The activation energy of traps determined could be related to the iron doping existing in the GaN buffer region of the device. However, the measured gate noise characteristics confirm also the existence of another type of traps in the structure. Further investigations using TCAD physical simulations are strongly required to identify the type of those

traps existing in the device and also their corresponding physical location. No leakage current was identified before and after measurements.

ACKNOWLEDGMENT

We greatly appreciate and acknowledge the Agence Nationale de la Recherche (ANR) and Direction Générale de l'Armement (DGA) France for funding under contract ANR-17-ASTR-0007-01 (COMPACT project).

REFERENCES

- [1] N. K. Subramani, *et al.*, "Low-Frequency Drain Noise Characterization and TCAD Physical Simulations of GaN HEMTs: Identification and Analysis of Physical Location of Traps," in *IEEE Electron Device Letters*, vol. 39, no. 1, pp. 107-110, Jan. 2018.
- [2] E. Paladino, *et al.*, "1/f noise : Implications for solidstate quantum information," *Rev. Mod. Phys.*, vol. 86, no. 2, pp. 361-418, Apr. 2014.
- [3] C. Kayis, *et al.*, "Field-assisted emission in AlGaIn/GaN heterostructure field-effect transistors using low-frequency noise technique," *J. Appl. Phys.*, vol. 109, no. 8, pp. 084522-1-084522-5, Apr. 2011.
- [4] M. Bouslama, *et al.*, "Low Frequency Drain Noise Characterization of Different Technologies of GaN HEMTs: Investigation of Trapping Mechanism," *2018 INMMIC*, Brive La Gaillarde, 2018, pp. 1-3.
- [5] A. A. L. D. Souza, J. C. Nallatamby, and M. Prigent, "Low-Frequency Noise Measurements of Bipolar Devices Under High DC Current Density: Whether Transimpedance or Voltage Amplifiers," in *European Microwave Integrated Circuits Conference*, 2006, pp. 114-117.
- [6] N.K. Subramani *et al.*, "Identification of GaN buffer Traps in microwave Power AlGaIn/GaN HEMTs Through Low Frequency S-parameters Measurements and TCAD-Based Physical Device."
- [7] R. Sommet, G. Mouginot, R. Quere, Z. Ouarch and M. Camiade "Thermal modeling and measurements of AlGaIn/GaN HEMTs including thermal boundary resistance", *Microelectronics. Journal*, vol. 43, no. 9, pp. 611-617, Sep. 2012. DOI: [10.1109/EuMIC.2016.7777511](https://doi.org/10.1109/EuMIC.2016.7777511).
- [8] D. Bisi *et al.*, "Deep-Level Characterization in GaN HEMTs-Part I: Advantages and Limitations of Drain Current Transient Measurements," in *IEEE Trans. Electron Devices*, vol. 60, no. 10, pp. 3166-3175, Oct. 2013.
- [9] O. Axelsson *et al.*, "Application Relevant Evaluation of Trapping Effects in AlGaIn/GaN HEMTs with Fe-Doped Buffer," in *IEEE Trans. Electron Devices*, vol. 63, no. 1, pp. 326-332, Jan. 2016.
- [10] M. Meneghini *et al.*, "Buffer Traps in Fe-Doped AlGaIn/GaN HEMTs: Investigation of the Physical Properties Based on Pulsed and Transient Measurements," in *IEEE Trans. Electron Devices*, vol. 61, no. 12, pp. 4070-4077, Dec. 2014.